

FOSHAN SONLAM HARDWARE FACTORY
FUZHOU SONLAM BUILDING MATERIALS CO.,LTD

TEL: 0591-87278561

WeChat: Crystal_Sonlam

WhatsApp:0086-18050157190

Email:sonlam@sonlam.net

Factory Address: No. 7, Guixingwei Industrial Zone, Shiling Village, Shishan Town,
Nanhai District, Foshan City, Guangdong Province, China

Head Office Address: Building 1, No. 10, Jinzhou North Road, Cangshan District,
Fuzhou, Fujian, China

SONLAM

Balustrade & Handrail Hardware Fittings

[Http://www.sonlam.net](http://www.sonlam.net)

FOSHAN SONLAM HARDWARE FACTORY
FUZHOU SONLAM BUILDING MATERIALS CO.,LTD



SONLAM

FOSHAN SONLAM HARDWARE FACTORY
FUZHOU SONLAM BUILDING MATERIALS CO.,LTD

We are the manufacturer specializing in the production of construction and decoration hardware fittings. And we manage with a collection of design, production, sales, export, engineering and service. We specialize in the manufacturing of wall fittings, door and windows fittings, locks, handrail fittings and so on. And we have the professional construction team, who will give the customers perfect service.

After long-termed management, our sales net is widely spread in more than 30 countries all over the world. And we also win good reputation with our high quality fittings, technology and service. We supply good fittings and technology to the customers all over the world; Meanwhile, we deliver credit to the whole world, and share all the good things with our customers, which including our professional service.

Let's develop quickly with all of the customers through global cooperation!

ISO9001:2008 CERTIFICATION



• Material:SS304,SS316 • Finish: satin finish(S),polish finish (P)



BJJ-01			
Item NO	L	H	T
BJ-01-504025-0(flat)	50	40	25
BJ-01-634527-0(flat)	63	45	27

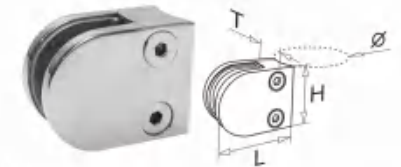

BJJ-02				
Item NO	L	H	T	Ø
BJ-02-504025-381	50	40	25	38.1
BJ-02-504025-424	50	40	25	42.4
BJ-02-504025-508	50	40	25	50.8
BJ-02-634527-381	63	45	27	38.1
BJ-02-634527-424	63	45	27	42.4
BJ-02-634527-483	63	45	27	48.3
BJ-02-634527-508	63	45	27	50.8



BJJ-03			
Item NO	L	H	T
BJ-03-454527-0(flat)	45	45	27
BJ-03-555530-0(flat)	55	55	30

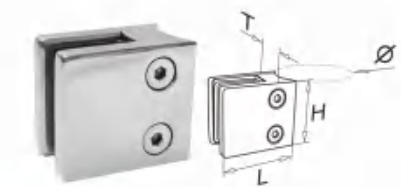

BJJ-04				
Item NO	L	H	T	Ø
BJ-04-454527-381	45	45	27	38.1
BJ-04-454527-424	45	45	27	42.4
BJ-04-454527-483	45	45	27	48.3
BJ-04-454527-508	45	45	27	50.8

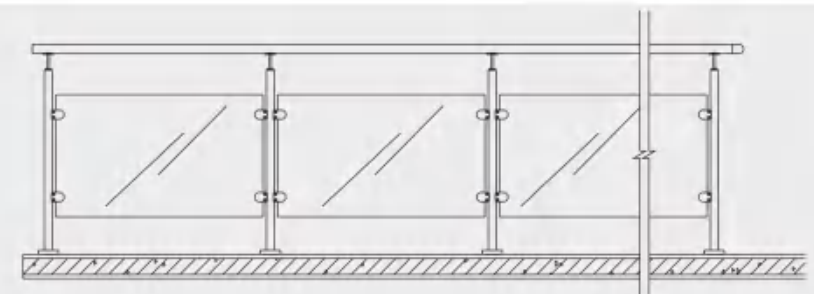

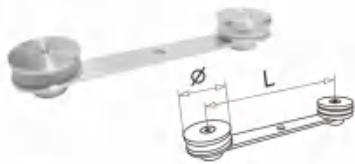

BJ-05			
Item NO	L	Ø	
BJ-05-172-50	172	50	
BJ-05-172-45	172	45	



BJ-06			
Item NO	L	Ø	
BJ-06-95-50	95	50	
BJ-06-95-45	95	45	

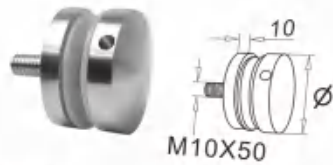

BJ-07	
Item NO	Ø
BJ-07-50	50

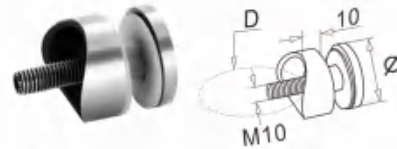

BJ-08		
Item NO	Ø	D
BJ-08-381	40	38.1
BJ-08-508	40	50.8

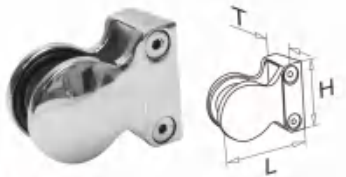

BJ-09			
Item NO	L	H	T
BJ-09-534325-0(flat)	53	43	25

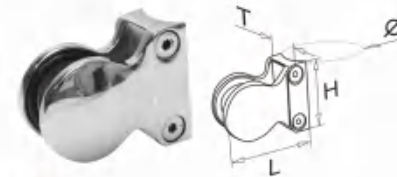

BJ-10				
Item NO	L	H	T	Ø
BJ-10-534325-381	53	43	25	38.1
BJ-10-534325-508	53	43	25	50.8

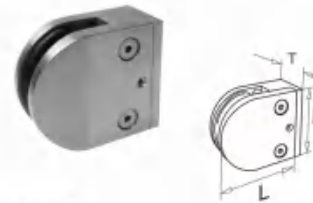

BJ-11			
Item NO	L	H	T
BJ-11-625327-0(flat)	62	53	27
BJ-11-605426-0(flat)	60	54	26 (Zinc alloy)

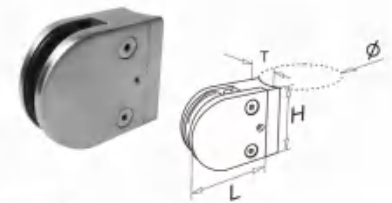

BJ-12				
Item NO	L	H	T	Ø
BJ-12-625327-381	62	53	27	38.1
BJ-12-625327-508	62	53	27	50.8
BJ-12-605426-381	60	54	26	38.1 (Zinc alloy)
BJ-12-605426-508	60	54	26	50.8 (Zinc alloy)

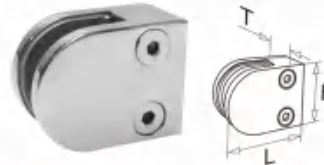

BJ-13 zinc with nickle/chrome plated			
Item NO	L	H	T
BJ-13-634527-0(flat)	63	45	27

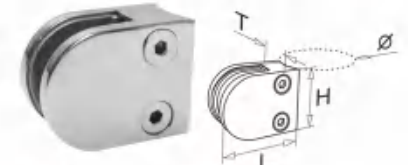

BJ-14 zinc with nickle/chrome plated				
Item NO	L	H	T	Ø
BJ-14-634527-381	63	45	27	38.1
BJ-14-634527-424	63	45	27	42.4
BJ-14-634527-508	63	45	27	50.8



BJ-15			
Item NO	L	H	T
BJ-15-554230-0(flat)	55	42	30

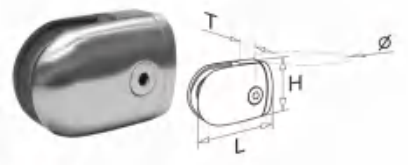

BJ-16				
Item NO	L	H	T	Ø
BJ-16-554230-381	55	42	30	38.1

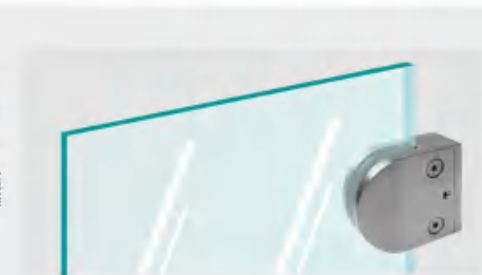
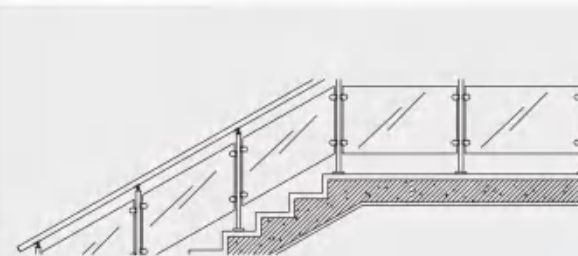



BJ-19			
Item NO	ϕ	H	
BJ-19-3830	38	30	
BJ-19-5030	50	30	
BJ-19-5050	50	50	

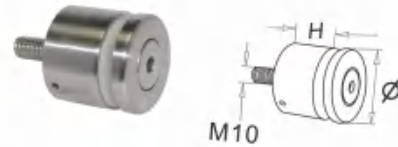

BJ-20			
Item NO	ϕ	H	
BJ-20-4025	40	25	
BJ-20-4050	40	50	
BJ-20-6050	60	50	

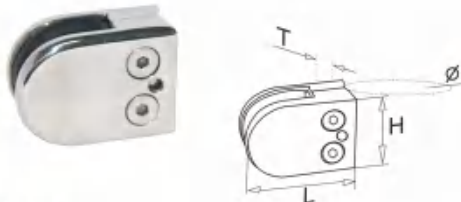

BJ-21					
Item NO	L	H	T	ϕ	
BJ-21-524525-0	52	45	25	0	
BJ-21-524525-381	52	45	25	38.1	
BJ-21-524525-424	52	45	25	42.4	
BJ-21-524525-508	52	45	25	50.8	
BJ-21-634527-0	63	45	27	0	
BJ-21-634527-381	63	45	27	38.1	
BJ-21-634527-424	63	45	27	42.4	
BJ-21-634527-508	63	45	27	50.8	



BJ-22 zinc with SS cover					
Item NO	L	H	T	ϕ	
BJ-22-664629-0	66	46	29	0	
BJ-22-664629-381	66	46	29	38.1	
BJ-22-664629-424	66	46	29	42.4	
BJ-22-664629-508	66	46	29	50.8	

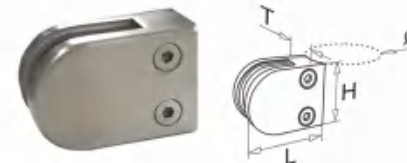

BJ-23					
Item NO	L	H	T	ϕ	
BJ-23-664530-0	66	45	30	0	
BJ-23-664530-424	66	45	30	42.4	
BJ-23-664530-508	66	45	30	50.8	
BJ-23-664530-762	66	45	30	76.2	

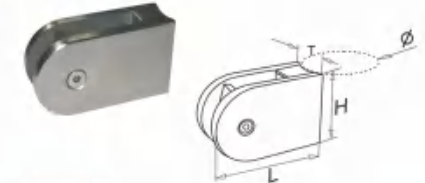

BJ-24					
Item NO	L	H	T	ϕ	
BJ-24-865029-45	86	50	29	45	

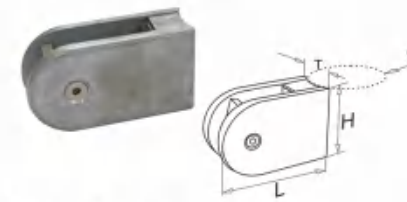

BJ-25 zinc					
Item NO	L	H	T	ϕ	
BJ-25-865029-45	86	50	29	45	

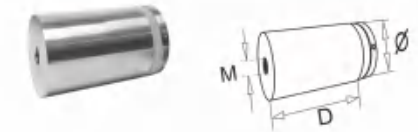

BJ-17			
Item NO	ϕ	D	M
BJ-17-3838	38	38	8
BJ-17-5050	50	50	12
BJ-17-4525	45	25	10
BJ-17-4538	45	38	10
BJ-17-4550	45	50	10
BJ-17-5015	50	15	12
BJ-17-5035	50	35	12

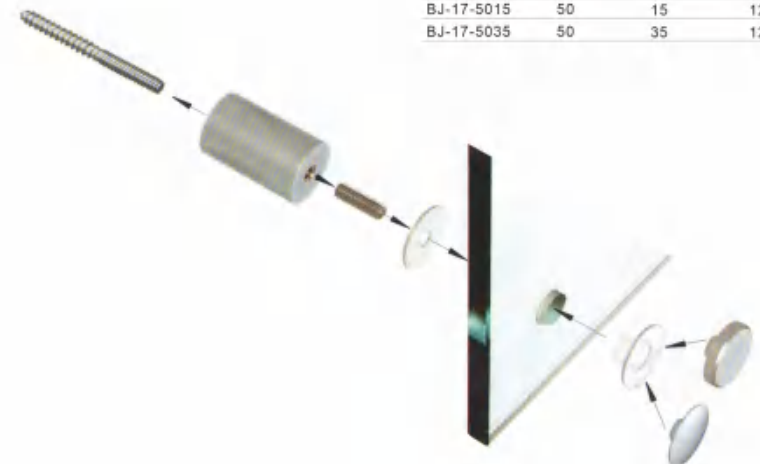

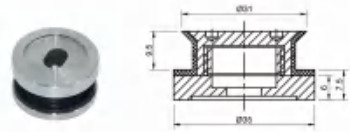

BJ-127	
Item NO	Ø
BJ-127	35

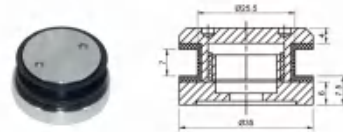

BJ-128	
Item NO	Ø
BJ-128	35



BJ-89	
Item NO	Ø
BJ-89-30	30
BJ-89-50	50



BJ-91	
Item NO	Ø
BJ-91-40	40

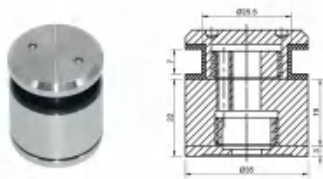

BJ-130	
Item NO	Ø
BJ-130	35



BJ-114	
Item NO	Ø
BJ-114-40	40

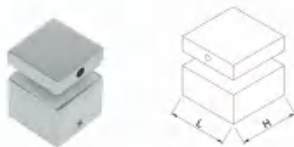

BJ-132		
Item NO	L	H
BJ-132-4040	40	40



BJ-63	
Item NO	Ø
BJ-63-424	42.4



BJ-65		
Item NO	Ø	H
BJ-65-5022	50	22



BJ-134		
Item NO	Ø	H
BJ-134-25	25	
BJ-134-32	32	



BJ-30		
Item NO	Ø	L
BJ-30	50	27

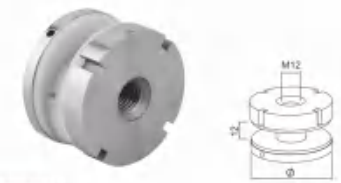

BJ-32		
Item NO	Ø	H
BJ-32-50	50	

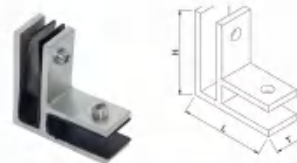

BJ-121			
Item NO	L	H	T
BJ-121-676726	67	67	26
BJ-121-676725	67	67	25
BJ-121-716125	71	61	25

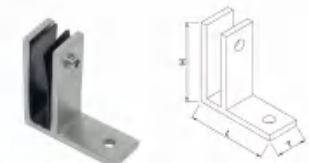

BJ-122			
Item NO	L	H	T
BJ-122-676726	67	67	26
BJ-122-676725	67	67	25
BJ-122-716125	71	61	25



BJ-66		
Item NO	L	H
BJ-66-10040	100	40

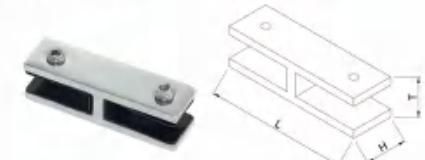

BJ-123			
Item NO	L	H	T
BJ-123-8826	88	26	24.5
BJ-123-8825	88	25	26
BJ-123-10125	101	25	25

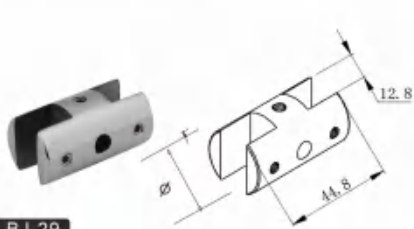

BJ-29

Item NO	ø
BJ-29	25

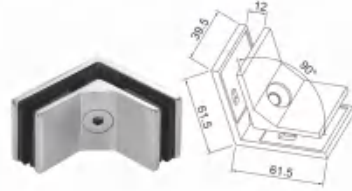

BJ-67

Item NO	L	H
BJ-67-6240	62	40

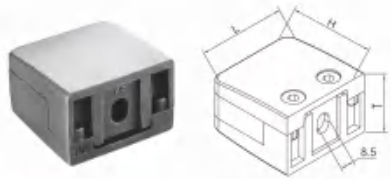

BJ-57

Item NO	L	H	T
BJ-57-555536-0	55	55	36

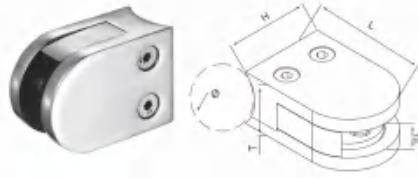

BJ-58

Item NO	L	H	T	ø
BJ-58-644830-0	64	48	30	0
BJ-58-704830-424	70	48	30	42.4

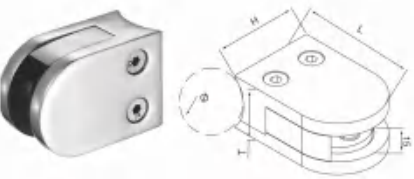

BJ-59 zinc with nickle/chrome plated

Item NO	L	H	T	ø
BJ-59-704830-0	70	48	30	0
BJ-59-704830-424	70	48	30	42.4

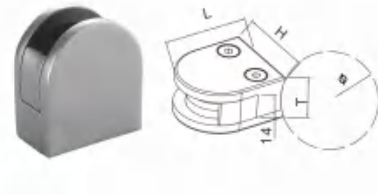

BJ-60

Item NO	L	H	T	ø
BJ-60-504525-508	50	45	25	50.8



BJ-34

Item NO	L	H	T	ø
BJ-34-0	45	45	25	0
BJ-34-381	45	45	25	38.1
BJ-34-508	45	45	25	50.8

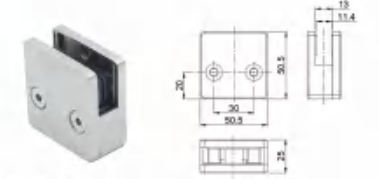

BJ-107

Item NO	L	H	T
BJ-107-505025	50	50	25

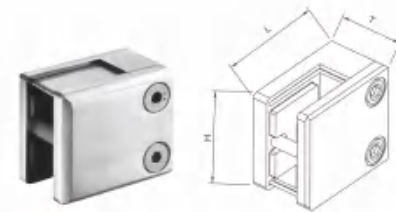

BJ-61

Item NO	L	H	T
BJ-61-504530-0	50	45	30

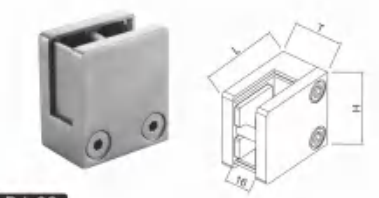

BJ-62

Item NO	L	H	T
BJ-64-504530-0	50	45	30

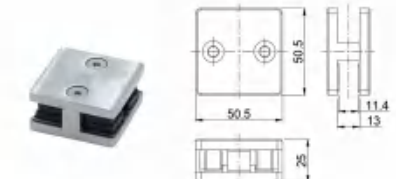

BJ-108

Item NO	L	H	T
BJ-108-505025	50	50	25

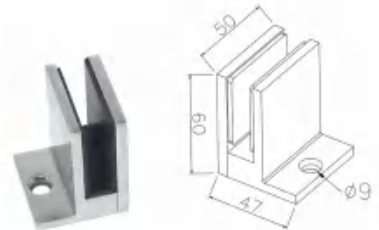

BJ-88

Item NO	L	H	T
BJ-88-605047	60	50	47



BJ-18				
Item NO	Ø	A	B	C
BJ-18-50	50	82	56	32
BJ-18-33	33	57.5	39	20

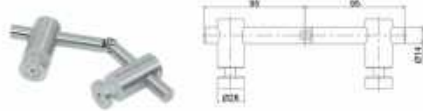

BJ-143	
Item NO	L
BJ-143	190

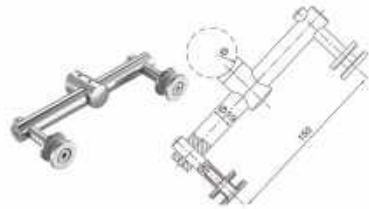

BJ-49	
Item NO	Ø
BJ-49-175-30	50.8



BJ-94		
Item NO	L	Ø
BJ-94-150	150	38.1



BJ-95		
Item NO	L	Ø
BJ-95-75	75	38.1

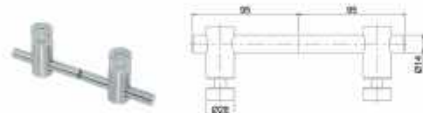

BJ-93	
Item NO	L
BJ-93	190

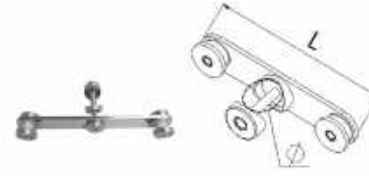

BJ-28		
Item NO	Ø	L
BJ-28-381	38.1	200
BJ-28-508	50.8	200



BJ-144		
Item NO	L	H
BJ-144	95	25

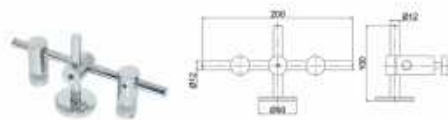

BJ-142		
Item NO	L	H
BJ-142-100	100	250



BJ-92	
Item NO	L
BJ-92-100	100



TJ-163	
Item NO	Ø
TJ-163-22	22
TJ-163-25	25



BJ-140	
Item NO	L
BJ-140-400	400



BJ-141	
Item NO	L
BJ-141-400	400



BJ-57A	
Item NO	L
BJ-57A-190	190
BJ-57A-222	222
BJ-57A-225	225

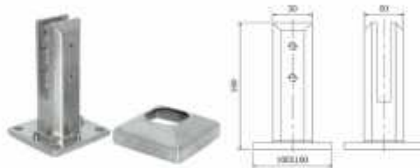

BJ-101	
Item NO	L
BJ-101-160	160

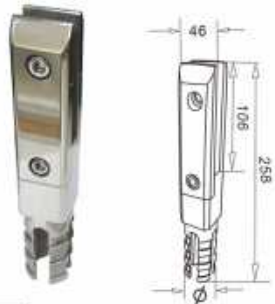

BJ-26	
Item NO	φ
BJ-26-45	45



BJ-27	
Item NO	φ
BJ-27-45	45



BJ-113	
Item NO	L
BJ-113-120	120
BJ-113-115	115



BJ-135	
Item NO	L
BJ-135-165	165



BJ-154	
Item NO	L
BJ-154-155	155



BJ-116		
Item NO	L	φ
BJ-116-250	250	32
BJ-116-300	300	32



SONLAM

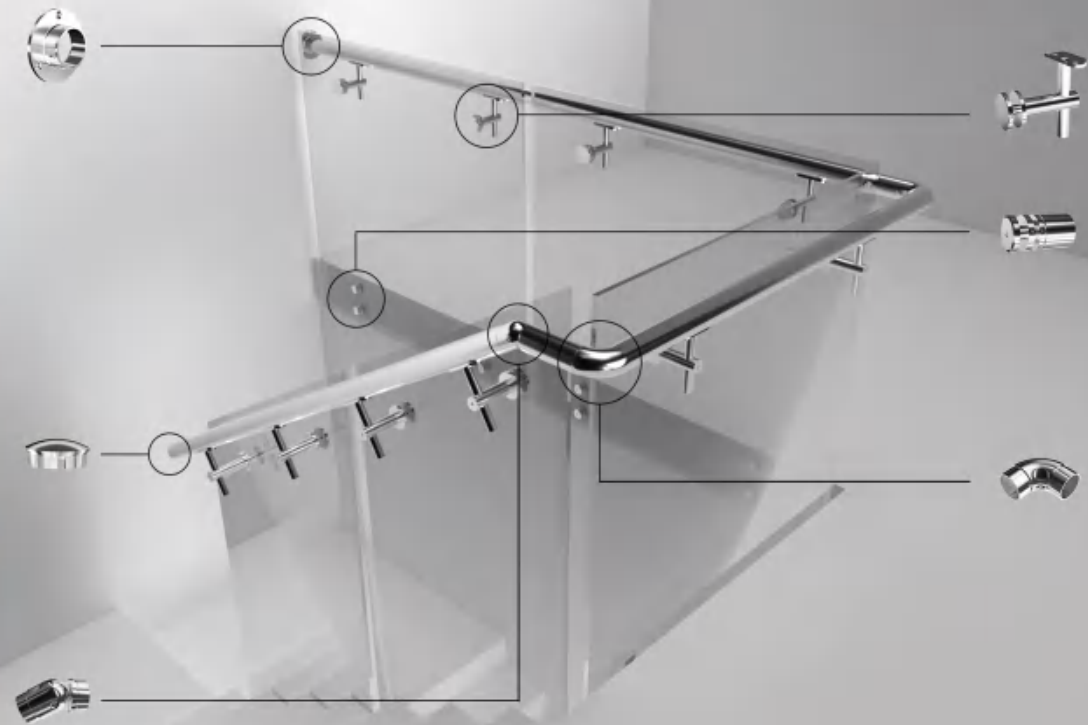

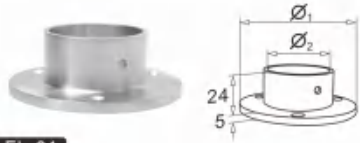

FL-01

Item NO	Ø ₁	Ø ₂
FL-01-16	16	50
FL-01-19	19	50
FL-01-254	25.4	53
FL-01-254-60	25.4	60
FL-01-254-69	25.4	69
FL-01-318	31.8	80
FL-01-381-69	38.1	69
FL-01-381-100	38.1	100
FL-01-424	42.4	80
FL-01-445	44.5	80
FL-01-483	48.3	100
FL-01-508-78	50.8	78
FL-01-508-100	50.8	100
FL-01-635	63.5	114
FL-01-762	76.2	120

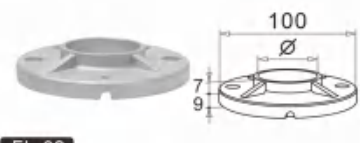

FL-02

Item NO	Ø
FL-02-483	48.3

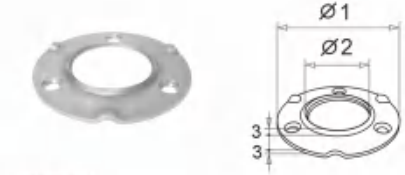

FL-05

Item NO	Ø ₁	Ø ₂
FL-05-127	65	12.7
FL-05-19	65	19
FL-05-254	65	25.4
FL-05-318	80	38.1
FL-05-381	80	38.1
FL-05-424	100	42.4
FL-05-483	100	48.3
FL-05-508	100	50.8

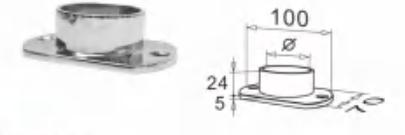

FL-06

Item NO	Ø
FL-06-381	38.1
FL-06-508	50.8



FL-07

Item NO	Ø ₁	Ø ₂	H
FL-07-381	75	38.1	28
FL-07-508	85	50.8	30



FL-08

Item NO	Ø
FL-08-508	50.8

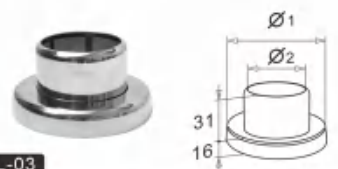

FL-03

Item NO	Ø ₁	Ø ₂
FL-03-254	54	25.4
FL-03-381	82	38.1
FL-03-424	87	42.4
FL-03-508	94	50.8

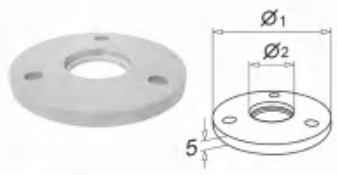

FL-04

Item NO	Ø ₁	Ø ₂
FL-04-381	80	38.1
FL-04-381	87	38.1
FL-04-424	87	42.4
FL-04-508	98	50.8
FL-04-635	98	63.5
FL-04-762	115	76.2



FL-09

Item NO	Ø
FL-09-381	38.1
FL-09-424	42.4
FL-09-508	50.8

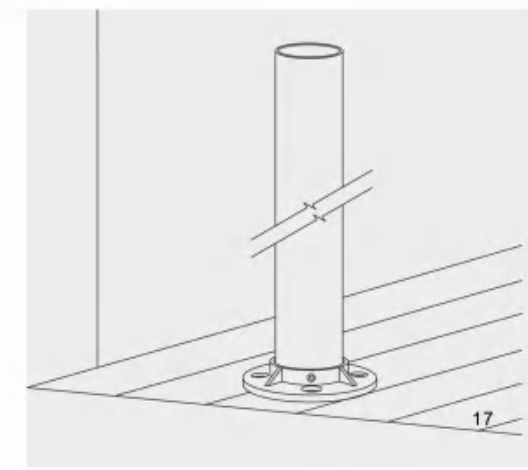
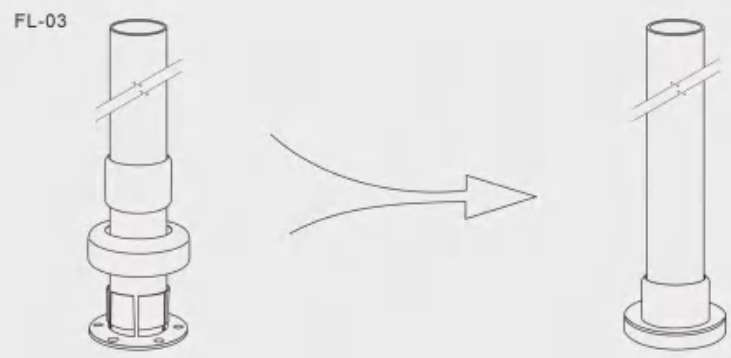



FL-10

Item NO	A	B	C
FL-10-4040	40×40	85	59
FL-10-5050	50×50	100	80

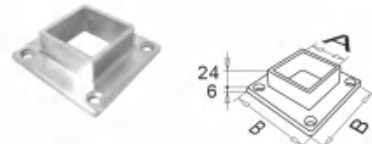

FL-11

Item NO	A	B
FL-11-2020	20×20	50×50
FL-11-2525	25×25	50×50
FL-11-3030	30×30	60×60
FL-11-4040	40×40	80×80
FL-11-5050	50×50	100×100

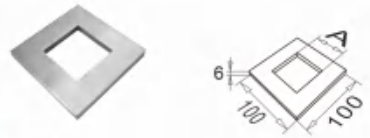

FL-12

Item NO	A
FL-12-4040	40×40
FL-12-5050	50×50



FL-13

Item NO	∅
FL-13-381	38.1
FL-13-424	42.4
FL-13-508	50.8



FL-14

Item NO	∅
FL-14-381	38.1
FL-14-508	50.8



FL-15

Item NO	∅
FL-15-381	38.1
FL-15-424	42.4
FL-15-508	50.8



FL-16

Item NO	A	B
FL-16-4040	40×40	78×78
FL-16-5050	50.8×50.8	100×100



FL-17

Item NO	∅	L
FL-17-424	42.4	69.2
FL-17-381	38.1	69.2
FL-17-508	50.8	69.2

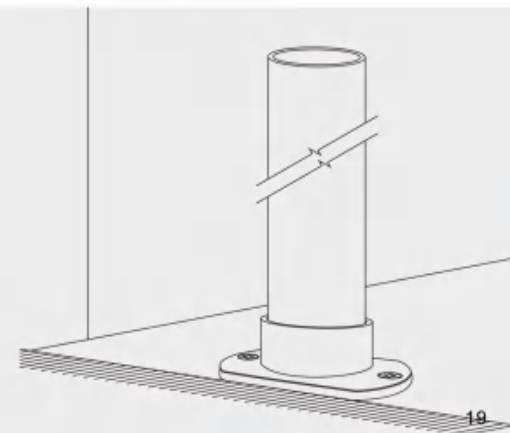

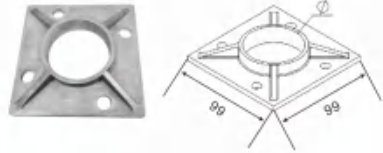

FL-19	
Item NO	∅
FL-19-508	50.8

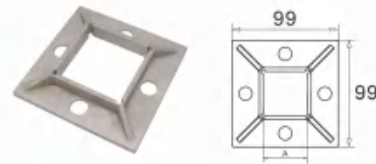

FL-20	
Item NO	A
FL-20-4040	40×40



FL-21		
Item NO	∅A	∅B
FL-21-381	38.1	65
FL-21-508	50.8	76

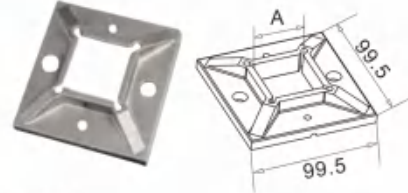

FL-22	
Item NO	A
FL-22-4040	40×40

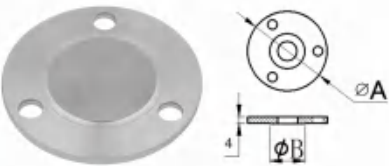

FL-23		
Item NO	∅A	∅B
FL-23-254	50	25.4
FL-23-381	60	38.1
FL-23-508	78	50.8



FL-24			
Item NO	∅	H	T
FL-24-381	38.1	70	6
FL-24-424	42.4	70	6
FL-24-508	50.8	70	6

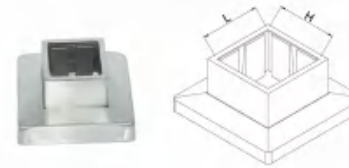

FL-32		
Item NO	L	H
FL-32-4040	40	40
FL-32-5050	50	50

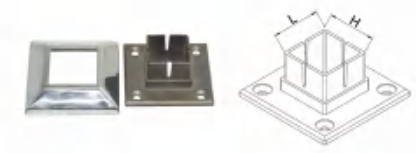

FL-37		
Item NO	L	H
FL-37-4040	40	40



FL-36	
Item NO	∅
FL-36-424	381



FL-39	
Item NO	∅
FL-39-381	381



FL-30	
Item NO	∅
FL-30-508	508

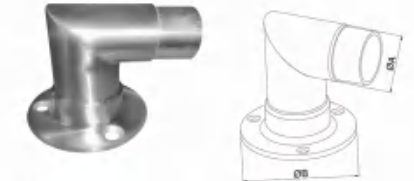

FL-25		
Item NO	∅A	∅B
FL-25-483	48.3	100

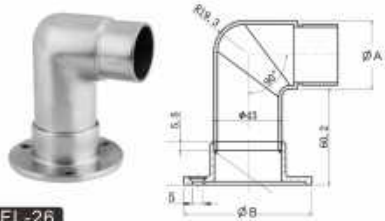

FL-26		
Item NO	$\varnothing A$	$\varnothing B$
FL-26-424	42.4	80



FL-27		
Item NO	A	B
FL-27-2521	25	21
FL-27-5025	50	25
FL-27-6040	60	40



FL-28	
Item NO	\varnothing
FL-28-508	50.8



FL-34-5010		
Item NO	L	H
FL-34-5010	50	10
FL-34-10015	100	15

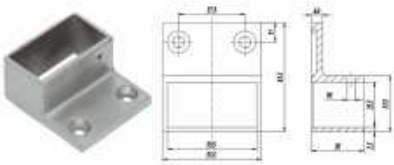

FL-34-5025		
Item NO	L	H
FL-34-5025	50	25



FL-40-5010		
Item NO	L	H
FL-40-5010	50	10



FL-41-5010		
Item NO	L	H
FL-41-5010	50	10

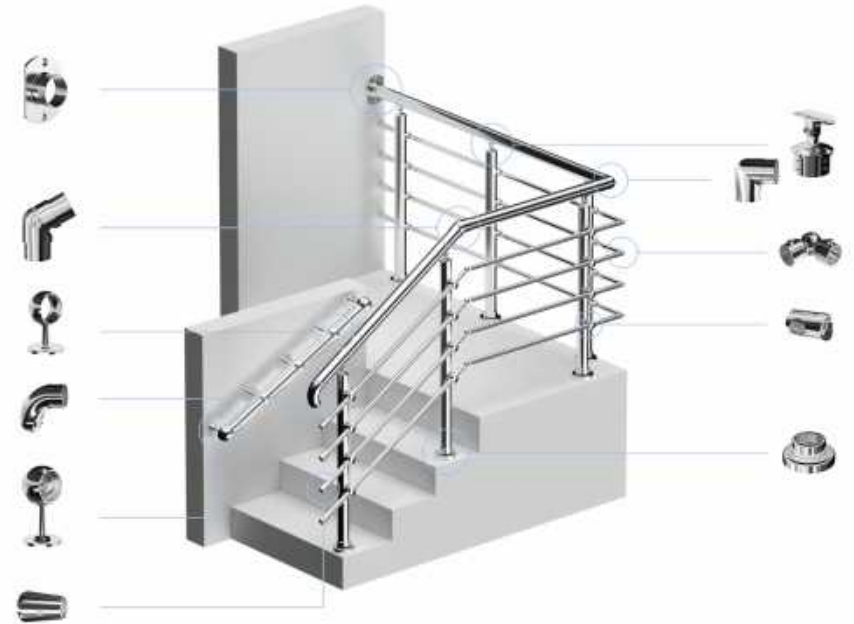



• Material:SS304,SS316 • Finish: satin finish(S),polish finish (P)



FG-01

Item NO	ø
FG-01-381	38.1
FG-01-424	42.4
FG-01-508	50.8

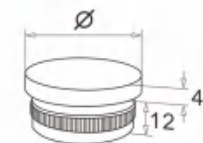

FG-02

Item NO	ø
FG-02-381	38.1
FG-02-424	42.4
FG-02-508	50.8

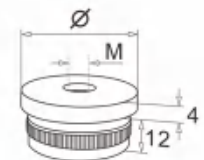

FG-03

Item NO	ø	M
FG-03-381	38.1	8
FG-03-424	42.4	8
FG-03-508	50.8	8

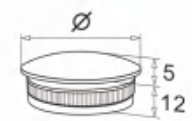

FG-04

Item NO	ø
FG-04-381	38.1
FG-04-424	42.4
FG-04-508	50.8

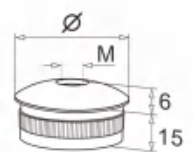

FG-05

Item NO	ø	M
FG-05-381	38.1	8
FG-05-424	42.4	8
FG-05-508	50.8	8

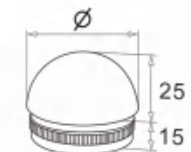

FG-06

Item NO	ø
FG-06-381	38.1
FG-06-424	42.4
FG-06-508	50.8

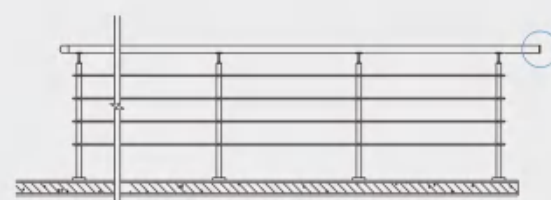

SONLAM

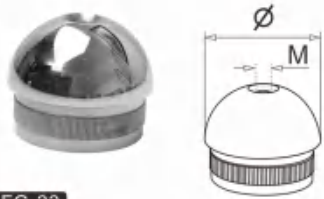

FG-22

Item NO	ø	M
FG-07-381	38.1	8
FG-07-424	42.4	8
FG-07-508	50.8	8

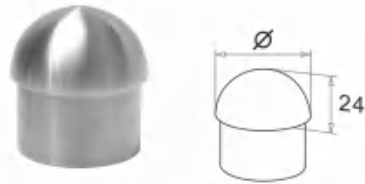

FG-08

Item NO	ø
FG-08-381	38.1
FG-08-424	42.4
FG-08-483	48.3
FG-08-508	50.8

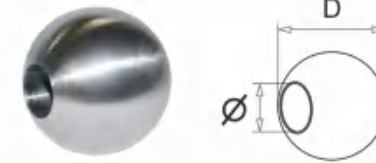

FG-11

Item NO	ø	D
FG-11-1220	12.5	20
FG-11-1225	12.5	25
FG-11-1230	12.5	30
FG-11-1235	12.5	35
FG-11-1625	16.5	25
FG-11-1630	16.5	30
FG-11-1635	16.5	35



FG-12

Item NO	ø
FG-12-381	38.1
FG-12-508	50.8



FG-09

Item NO	ø
FG-09-254	25.4
FG-09-381	38.1
FG-09-424	42.4
FG-09-483	48.3
FG-09-508	50.8



FG-10

Item NO	ø
FG-10-16	16
FG-10-254	25.4
FG-10-381	38.1
FG-10-424	42.4
FG-10-483	48.3
FG-10-508	50.8



FG-13

Item NO	ø
FG-13-254	25.4
FG-13-381	38.1
FG-13-424	42.4
FG-13-483	48.3
FG-13-508	50.8



FG-14

Item NO	A	B
FG-14-5336	53	36

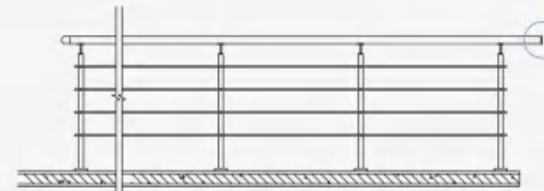
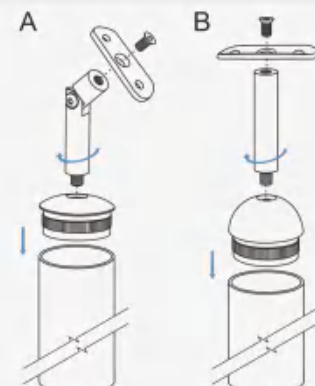
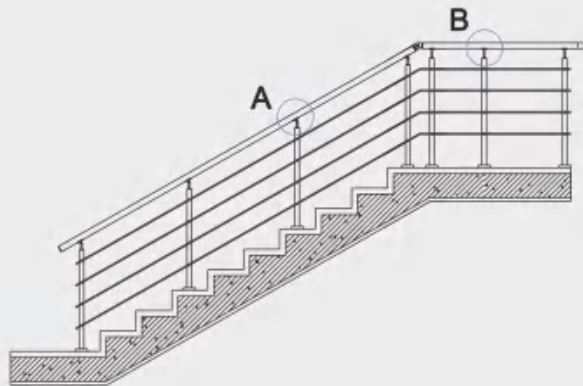



FG-15

Item NO	A
FG-15-4040	40x40
FG-15-5050	50x50



FG-16

Item NO	Ø	H
FG-16-12	12	14
FG-16-16	16	19



FG-17

Item NO	Ø
FG-17-381	38.1
FG-17-424	42.4
FG-17-508	50.8



FG-18

Item NO	Ø
FG-18-12	12
FG-18-16	16



FG-19

Item NO	L	H
FG-19-4040	40	40

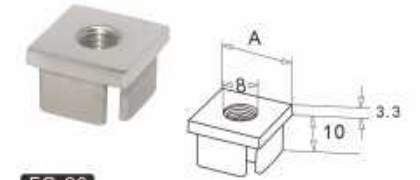

FG-20

Item NO	A
FG-20-1414	14x14
FG-20-2020	20x20



FG-21

Item NO	Ø
FG-21-424	42.4



FG-22

Item NO	Ø	H
FG-22-50	50	25

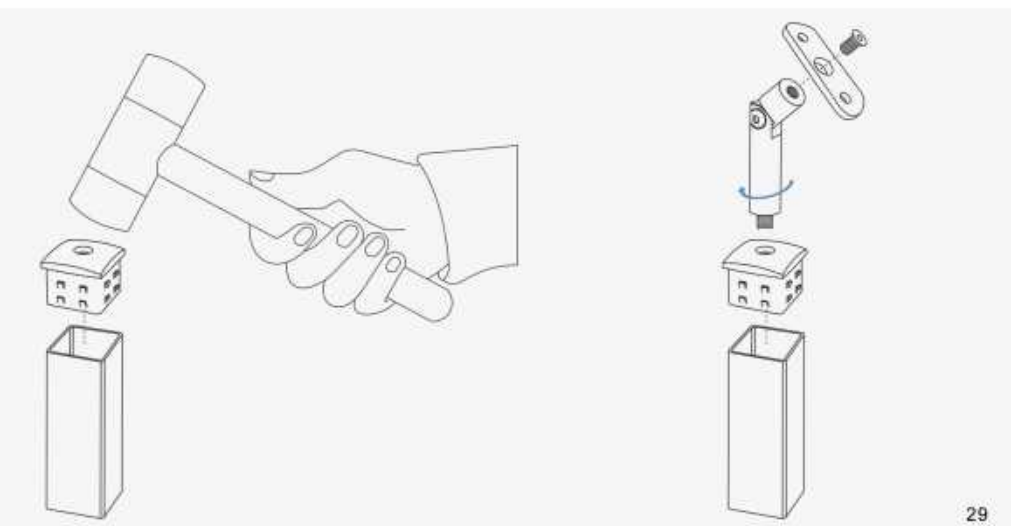
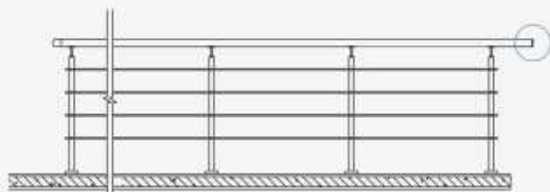

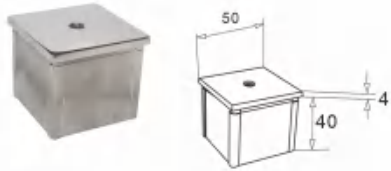

FG-23

Item NO	L	T
FG-23-5050	50	50

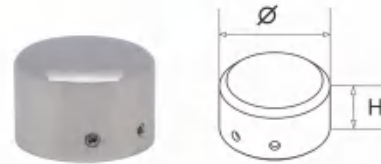

FG-24

Item NO	ϕ	H
FG-24-424	42.4	30
FG-24-508	50.8	43

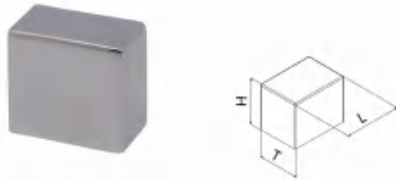

FG-25

Item NO	L	T	H
FG-25-2513	25	13	22

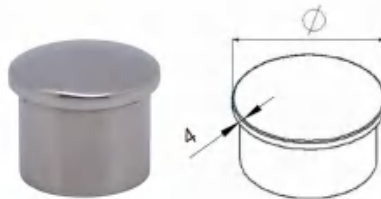

FG-26

Item NO	ϕ
FG-26-254	25.4
FG-26-635	63.5
FG-26-762	76.2
FG-26-1016	101.6



FG-27

Item NO	ϕ	H
FG-27	21	12



FG-28

Item NO	ϕ	H
FG-28-254	25.4	12



FG-29

Item NO	ϕA	ϕB
FG-29-12W	12	90
FG-29-16W	16	90
FG-29-12Y	12	30
FG-29-16Y	16	30

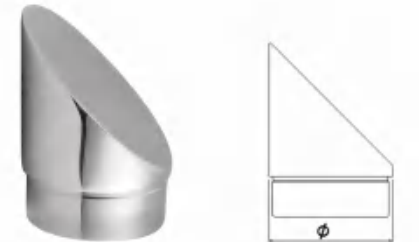

FG-30

Item NO	ϕ
FG-30-762	76.2

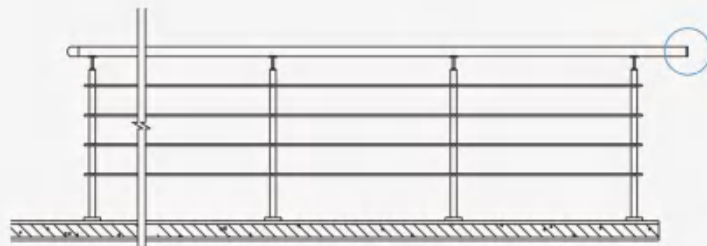

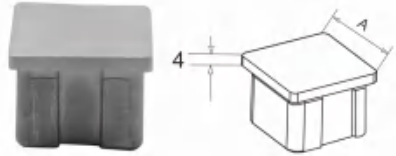

FG-31	
Item NO	A
FG-31-4040	40x40

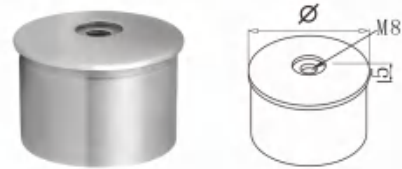

FG-32	
Item NO	Ø
FG-32-508	50.8

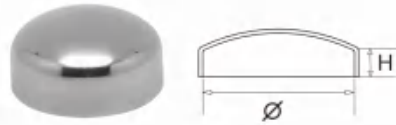

FG-33		
Item NO	Ø	H
FG-33-16	16	10
FG-33-381	38.1	7
FG-33-508	50.8	9



FG-34	
Item NO	Ø
FG-34-381	38.1

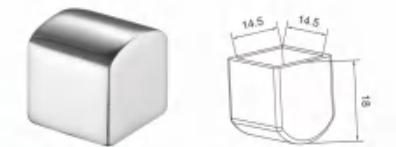

FG-35		
Item NO	L	H
FG-35-1414	14	14

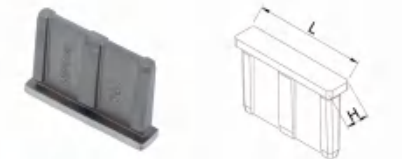

FG-15		
Item NO	L	H
FG-15-5010	50	10
FG-15-10015	100	15



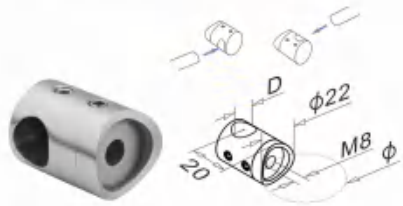

JT-01 closed right/closed left

Item NO	D	φ
JT-01-12-0Z	12	
JT-01-12-381Z	12	38.1
JT-01-12-424Z	12	42.4
JT-01-12-508Z	12	50.8
JT-01-16-0Y	16	
JT-01-16-381Y	16	38.1
JT-01-16-424Y	16	42.4
JT-01-16-508Y	16	50.8

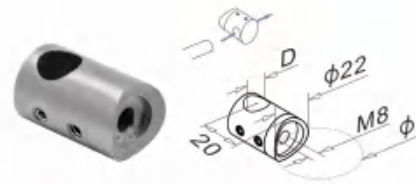

JT-02

Item NO	D	φ
JT-02-12-0(flat)	12	0
JT-02-12-381	12	38.1
JT-02-12-424	12	42.4
JT-02-12-483	12	48.3
JT-02-12-508	12	50.8
JT-02-12-603	12	60.3
JT-02-16-0(flat)	16	0
JT-02-16-381	16	38.1
JT-02-16-424	16	42.4
JT-02-16-483	16	48.3
JT-02-16-508	16	50.8
JT-02-16-603	16	60.3

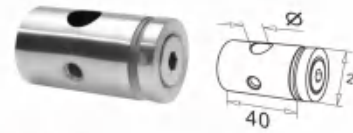

JT-03

Item NO	φ
JT-03-12	12
JT-03-16	16

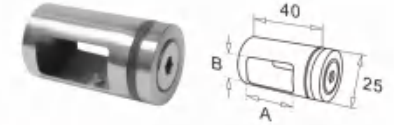

JT-04

Item NO	A	B
JT-04-2513	25	13



JT-05

Item NO	φa	φb
JT-05-12-12	12	12
JT-05-12-16	12	16
JT-05-16-16	16	16



JT-06

Item NO	φ
JT-06-12	12
JT-06-16	16



JT-07

Item NO	D
JT-07-25-0(flat)	25

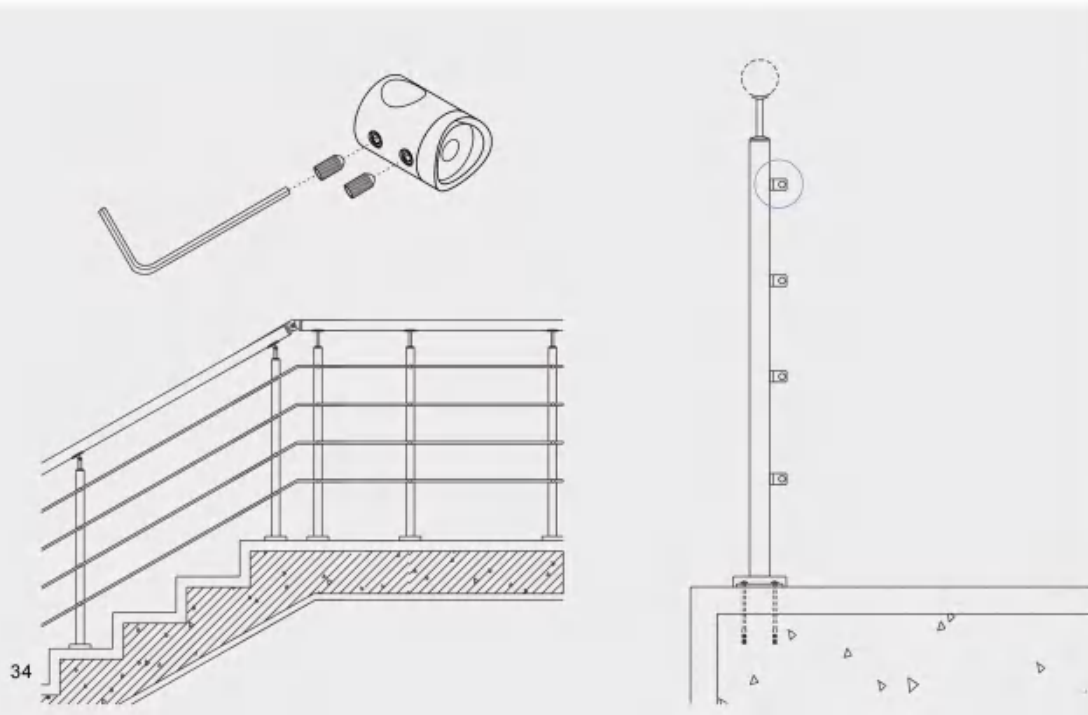



JT-08		
Item NO	D	∅
JT-08-381	25	38.1
JT-08-424	25	42.4
JT-08-483	25	48.3
JT-08-508	25	50.8
JT-08-603	25	60.3



JT-09	
Item NO	∅
JT-09-12	12
JT-09-16	16



JT-10	
Item NO	∅
JT-10-12	12
JT-10-16	16



JT-11	
Item NO	∅
JT-11-12	12
JT-11-16	16

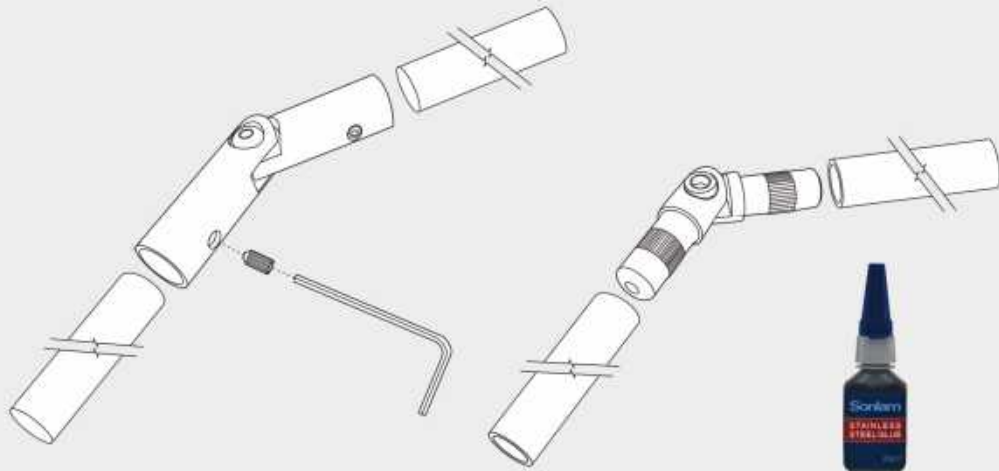

JT-12	
Item NO	∅
JT-12-12	12
JT-12-16	16



JT-13	
Item NO	∅
JT-13-12	12
JT-13-16	16

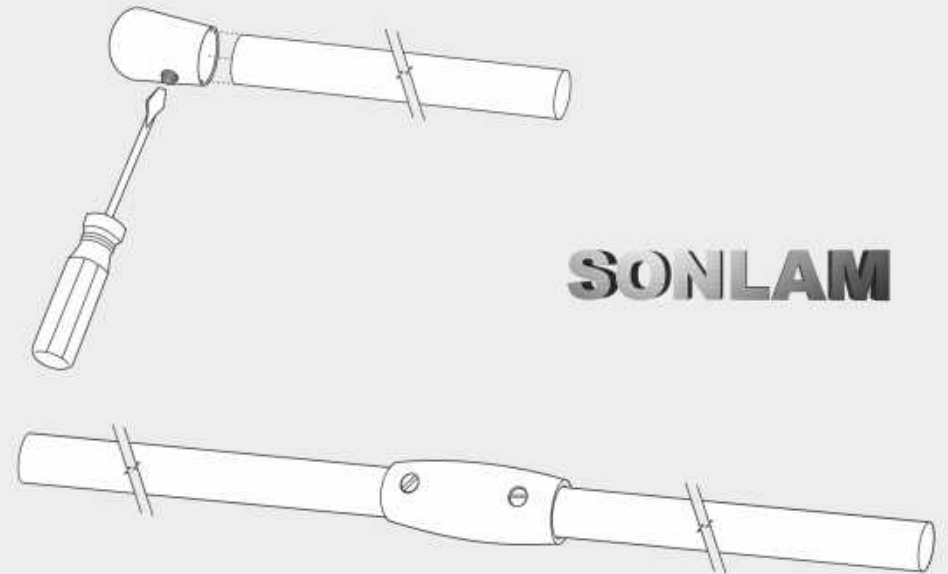



JT-14

Item NO	∅
TJ-14-381	38.1
TJ-14-424	42.4
TJ-14-483	48.3
TJ-14-508	50.8



JT-15

Item NO	∅
JT-15-12	12
JT-15-16	16



JT-16

Item NO	∅	D	A
JT-16-2212-424	42.4	22	12
JT-16-2214-424	42.4	22	14

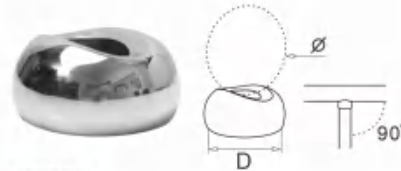

JT-17

Item NO	D	∅
JT-17-254-424-90	25.4	42.4
JT-17-381-424-90	38.1	42.4
JT-17-424-424-90	42.4	42.4
JT-17-508-508-90	50.8	50.8

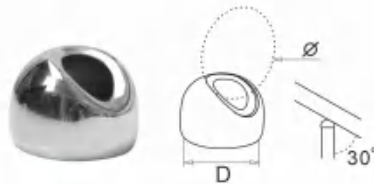

JT-18

Item NO	D	∅
JT-18-254-424-30	25.4	42.4
JT-18-381-424-30	38.1	42.4
JT-18-424-424-30	42.4	42.4
JT-18-508-508-30	50.8	50.8



JT-19

Item NO	∅
JT-19-12	12
JT-19-16	16

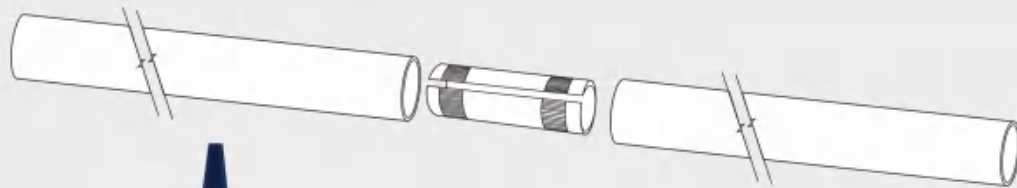

JT-20

Item NO	∅	M
JT-20-816	8	16



JT-21

Item NO	∅	H
JT-21-337	30	60
JT-21-424	38	60

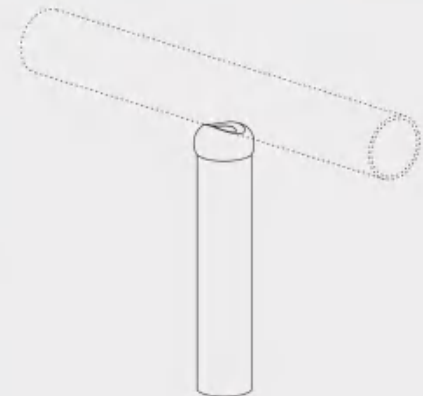
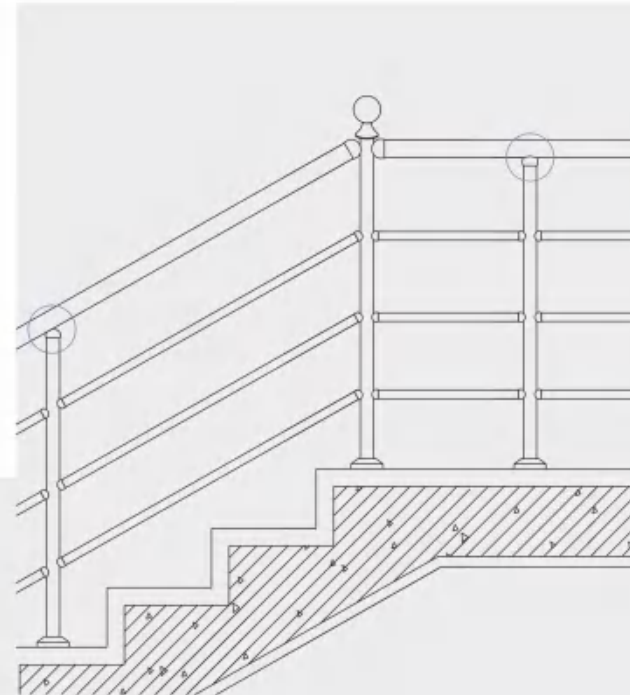



JT-22	
Item NO	∅
JT-22-424	42.4

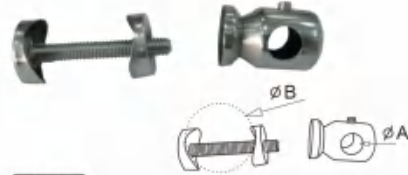

JT-23		
Item NO	∅A	∅B
JT-23-12	12	38.1
JT-23-16	16	50.8
JT-23-19	19	50.8



JT-24		
Item NO	∅	L
JT-24-508	50.8	69.2



JT-25		
Item NO	∅	L
JT-25-16	16	25



JT-26	
Item NO	∅
TJ-26-424	42.4



JT-27	
Item NO	∅
JT-27-12	12
JT-27-127	12.7
JT-27-16	16
JT-27-19	19
JT-27-254	25.4



JT-28		
Item NO	∅A	∅B
JT-28-127		12.7
JT-28-127-508	50.8	12.7
JT-28-16		16
JT-28-16-508	50.8	16

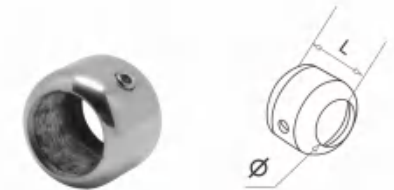

JT-29		
Item NO	∅	L
JT-29-16	16	21

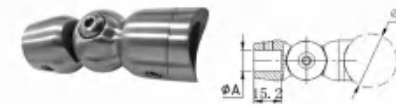

JT-30		
Item NO	∅A	∅B
JT-30-12-424	12	42.4

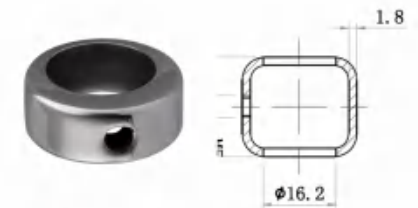

JT-31	
Item NO	∅
JT-31-16	16

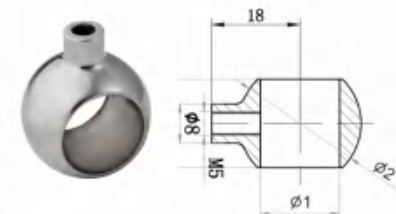

JT-32		
Item NO	∅1	∅2
JT-32-16	16	25
JT-32-25	25	33

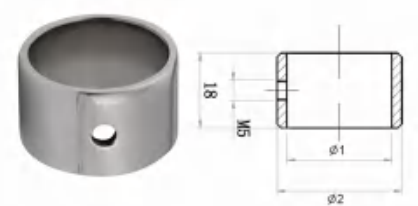

JT-33		
Item NO	∅1	∅2
JT-33-25	25	30
JT-33-32	32	38
JT-33-381	38.1	42

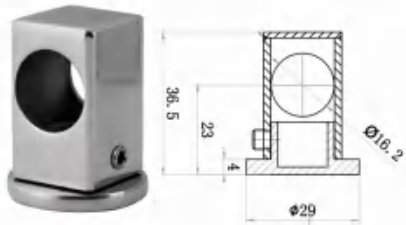

JT-34		
Item NO	∅1	∅2
JT-34-16	16	29

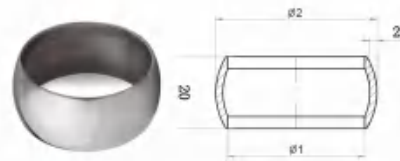

JT-35		
Item NO	∅1	∅2
JT-35-32	32	38
JT-35-381	38.1	45
JT-35-508	50.8	57
JT-35-635	63.5	70

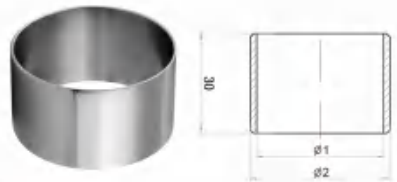

JT-36		
Item NO	∅1	∅2
JT-36-381	38.1	42
JT-36-508	50.8	54

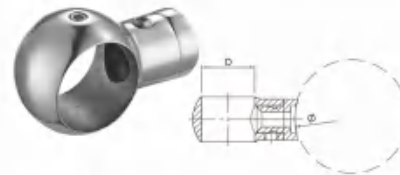

JT-39		
Item NO	D	∅
JT-39-19-508	19	50.8



JT-46		
Item NO	L	H
JT-46-1414	14	14



JT-47	
Item NO	∅
JT-47-16	16

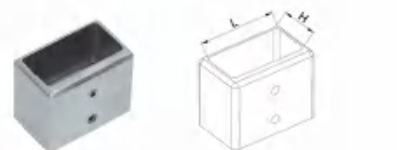

JT-55		
Item NO	L	H
JT-55-4020	40	20
JT-55-2525	25	25

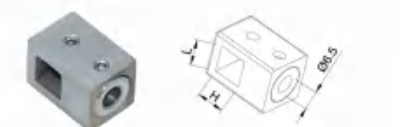

JT-56		
Item NO	L	H
JT-56-1010	10	10
JT-56-1414	14	14
JT-56-1515	15	15
JT-56-1616	16	16





Q-01	
Item NO	Ø
Q-01-381	38.1
Q-01-424	42.4
Q-01-508	50.8

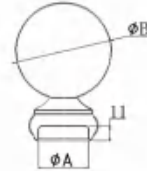

Q-02		
Item NO	Ø A	Ø B
Q-02-381	38.1	66
Q-02-508	50.8	80

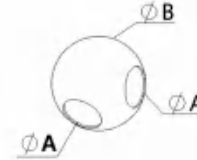

Q-07		
Item NO	Ø A	Ø B
Q-07-100-2-90	50.8	100
Q-07-100-2-180	50.8	100
Q-07-100-2-135	50.8	100
Q-07-100-1	50.8	100

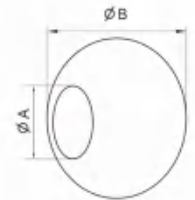

Q-08		
Item NO	Ø A	Ø B
Q-08-1225	12.5	25
Q-08-1230	12.5	30



Q-03		
Item NO	Ø A	Ø B
Q-03-381	38.1	50
Q-03-424	42.4	60
Q-03-508	50.8	60
Q-03-508	50.8	80



Q-04		
Item NO	Ø	M
Q-04-50	50	8
Q-04-80	80	10
Q-04-100	100	10
Q-04-150	150	10
Q-04-200	200	10

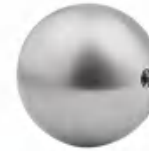

Q-09		
Item NO	Ø	M
Q-09-0620	20	6
Q-09-0625	25	6
Q-09-0630	30	6
Q-09-0635	35	6



Q-10	
Item NO	Ø
Q-10-508	50.8

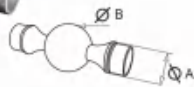

Q-05		
Item NO	A	B
Q-05-381	38.1	50
Q-05-508	50.8	60



Q-06	
Item NO	Ø
Q-06-59	59
Q-06-80	80
Q-06-100	100
Q-06-120	120
Q-06-150	150
Q-06-200	200

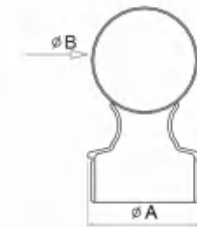

Q-11		
Item NO	Ø A	Ø B
Q-11-254	25.4	50
Q-11-381	38.1	50
Q-11-508	50.8	80
Q-11-635	63.5	80
Q-11-635	63.5	100
Q-11-762	76.2	100

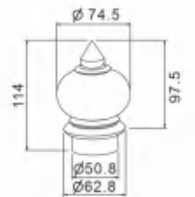

Q-12	
Item NO	Ø
Q-12-508-80	50.8



TJ-05		
Item NO	D	∅
TJ-05-381-381	38.1	38.1
TJ-05-381-508	38.1	50.8
TJ-05-424-424	42.4	42.4
TJ-05-424-483	42.4	48.3
TJ-05-483-483	48.3	48.3
TJ-05-508-508	50.8	50.8



TJ-06		
Item NO	∅	
TJ-06-381	38.1	
TJ-06-424	42.4	
TJ-06-483	48.3	
TJ-06-508	50.8	

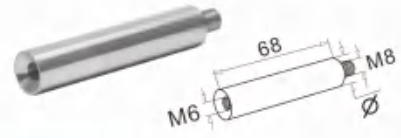

TJ-07		
Item NO	∅	
TJ-07-6-8	14	



TJ-08		
Item NO	∅	
TJ-08-6-8	14	



TJ-09		
Item NO	∅	
TJ-09-0 (flat)	0	
TJ-09-381	38.1	
TJ-09-424	42.4	
TJ-09-483	48.3	
TJ-09-508	50.8	



TJ-10		
Item NO	∅A	∅B
TJ-10-381-381	38.1	38.1
TJ-10-381-508	38.1	50.8
TJ-10-424-424	42.4	42.4
TJ-10-424-483	42.4	48.3
TJ-10-508-508	50.8	50.8

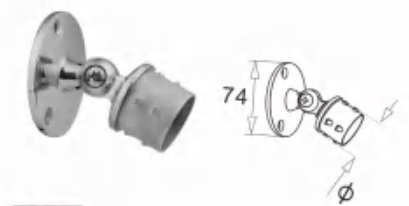

TJ-11		
Item NO	∅	
TJ-11-381	38.1	
TJ-11-424	42.4	
TJ-11-483	48.3	
TJ-11-508	50.8	



TJ-12		
Item NO	∅	
TJ-12-381	38.1	
TJ-12-424	42.4	
TJ-12-483	48.3	
TJ-12-508	50.8	



TJ-13		
Item NO	D	∅
TJ-13-381-381	38.1	38.1
TJ-13-381-508	38.1	50.8
TJ-13-424-424	42.4	42.4
TJ-13-424-483	42.4	48.3
TJ-13-483-483	48.3	48.3
TJ-13-508-508	50.8	50.8



TJ-14		
Item NO	M	∅
TJ-14-01	6	70



TJ-15	
Item NO	∅
TJ-15-01	12



TJ-16	
Item NO	∅
TJ-16-0 (flat)	0
TJ-16-381	38.1
TJ-16-424	42.4
TJ-16-483	48.3
TJ-16-508	50.8



TJ-17	
Item NO	∅
TJ-17-0 (flat)	0
TJ-17-381	38.1
TJ-17-424	42.4
TJ-17-483	48.3
TJ-17-508	50.8



TJ-18	
Item NO	∅
TJ-18-381	38.1
TJ-18-424	42.4
TJ-18-483	48.3
TJ-18-508	50.8



TJ-19	
Item NO	∅
TJ-19-0 (flat)	0
TJ-19-381	38.1
TJ-19-424	42.4
TJ-19-483	48.3
TJ-19-508	50.8

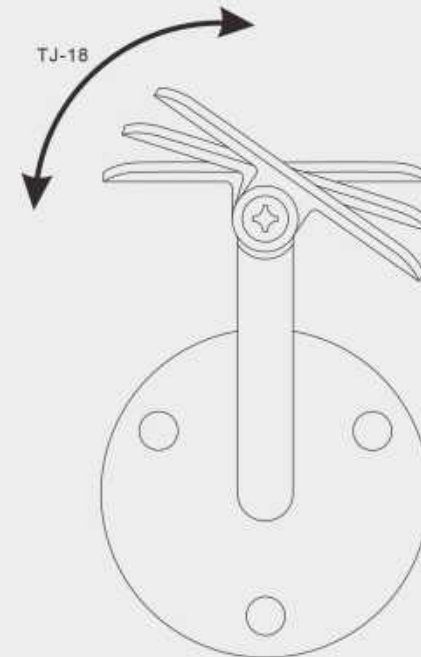

SONLAM



SONLAM



TJ-20	
Item NO	∅
TJ-20-0 (flat)	0
TJ-20-381	38.1
TJ-20-424	42.4
TJ-20-483	48.3
TJ-20-508	50.8



TJ-21	
Item NO	∅
TJ-21-381	38.1
TJ-21-424	42.4
TJ-21-483	48.3
TJ-21-508	50.8



TJ-22	
Item NO	∅
TJ-22-0 (flat)	0
TJ-22-381	38.1
TJ-22-424	42.4
TJ-22-483	48.3
TJ-22-508	50.8

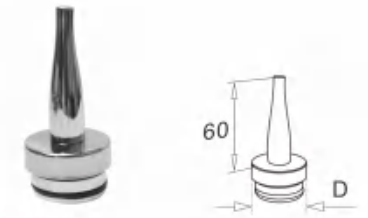

TJ-23	
Item NO	D
TJ-23-381	38.1
TJ-23-424	42.4

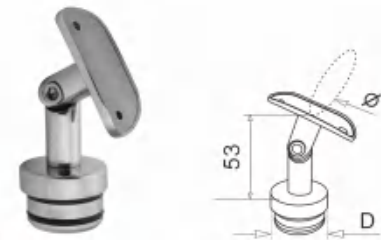

TJ-24		
Item NO	D	∅
TJ-24-381-508	38.1	50.8
TJ-24-424-483	42.4	48.3



TJ-25		
Item NO	D	∅
TJ-25-381-508	38.1	50.8
TJ-25-424-483	42.4	48.3

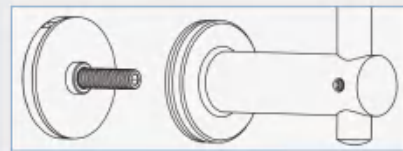
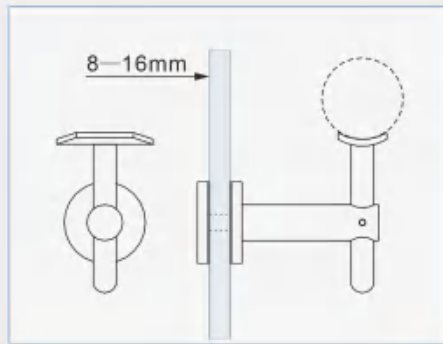

SONLAM

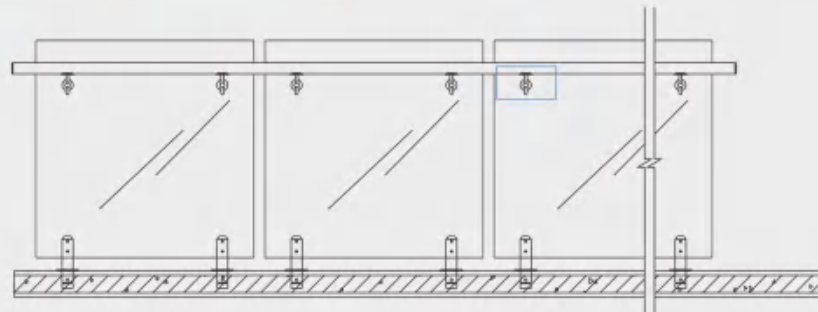



TJ-26

Item NO	ø
TJ-26-381	38.1
TJ-26-424	42.4
TJ-26-483	48.3



TJ-27

Item NO	øa	øb
TJ-27-381-381	38.1	38.1
TJ-27-381-508	38.1	50.8
TJ-27-424-424	42.4	42.4
TJ-27-424-483	42.4	48.3
TJ-27-508-508	50.8	50.8

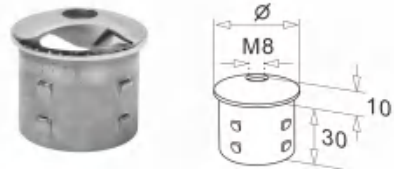

TJ-28

Item NO	ø
TJ-28-381	38.1
TJ-28-424	42.4
TJ-28-483	48.3
TJ-28-508	50.8



TJ-29

Item NO	ø
TJ-29-381	38.1
TJ-29-424	42.4
TJ-29-508	50.8

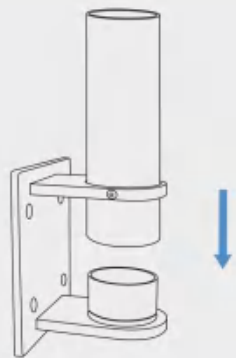

TJ-30

Item NO	D	ø
TJ-30-381-381	38.1	38.1
TJ-30-381-508	38.1	50.8
TJ-30-424-424	42.4	42.4
TJ-30-424-483	42.4	48.3
TJ-30-483-483	48.3	48.3
TJ-30-508-508	50.8	50.8



TJ-31

Item NO	øA	øB
TJ-31-381-508	38.1	50.8
TJ-31-508-508	50.8	50.8



TJ-32

Item NO	D
TJ-32-381	38.1
TJ-32-424	42.4
TJ-32-508	50.8



TJ-33

Item NO	øA	øB
TJ-33-381-381	38.1	38.1
TJ-33-381-508	38.1	50.8
TJ-33-424-424	42.4	42.4
TJ-33-424-483	42.4	48.3
TJ-33-508-508	50.8	50.8

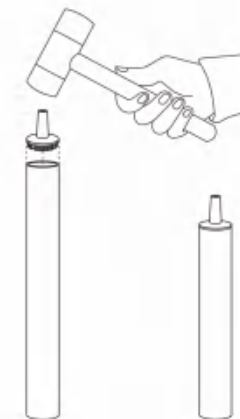



TJ-34		
Item NO	ØA	ØB
TJ-34-12-254	12	25.4
TJ-34-12-381	12	38.1
TJ-34-12-424	12	42.4
TJ-34-12-508	12	50.8



TJ-35		
Item NO	Øa	Øb
TJ-35-381-381	38.1	38.1
TJ-35-381-508	38.1	50.8
TJ-35-424-424	42.4	42.4
TJ-35-424-483	42.4	48.3
TJ-35-483-483	48.3	48.3
TJ-35-508-508	50.8	50.8



TJ-36		
Item NO	D	Ø
TJ-36-381-0	38.1	0
TJ-36-381-381	38.1	38.1
TJ-36-381-508	38.1	50.8
TJ-36-424-424	42.4	42.4
TJ-36-424-483	42.4	48.3
TJ-36-483-483	48.3	48.3
TJ-36-508-508	50.8	50.8



TJ-37		
Item NO	D	Ø
TJ-37-381-381	38.1	38.1
TJ-37-381-508	38.1	50.8
TJ-37-424-424	42.4	42.4
TJ-37-424-483	42.4	48.3
TJ-37-508-508	50.8	50.8

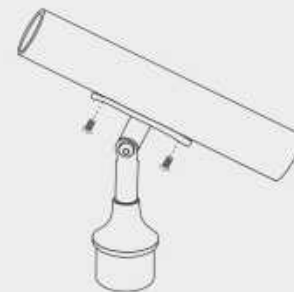
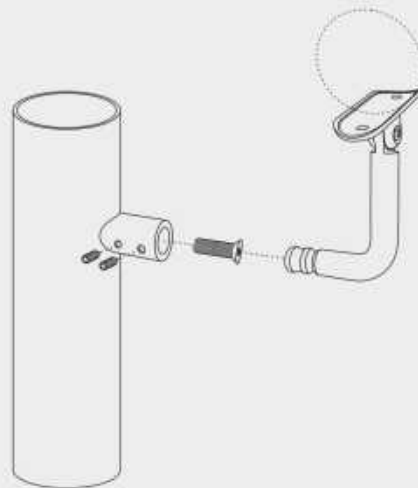
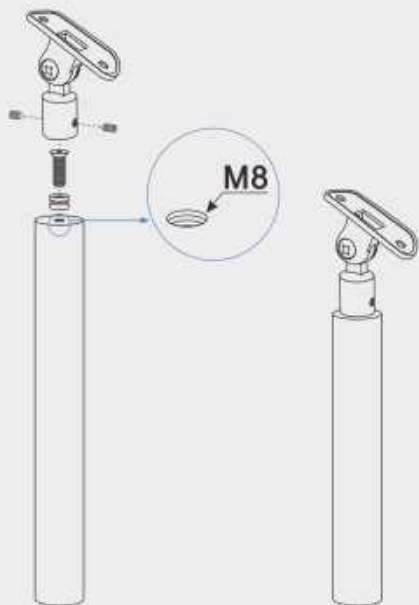

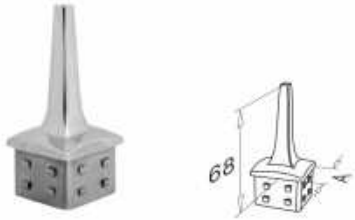

TJ-38	
Item NO	A
TJ-38-4040	40x40



TJ-39	
Item NO	∅
TJ-39-0	0
TJ-39-424	42.4
TJ-39-508	50.8



TJ-40	
Item NO	∅
TJ-40-0 (flat)	0
TJ-40-381	38.1
TJ-40-424	42.4
TJ-40-483	48.3
TJ-40-508	50.8



TJ-41	
Item NO	A
TJ-41-4040	40x40
TJ-41-5151	51x51



TJ-42	
Item NO	∅
TJ-42-01	50



TJ-43	
Item NO	∅
TJ-43-0	0
TJ-43-381	38.1
TJ-43-424	42.4
TJ-43-483	48.3
TJ-43-508	50.8

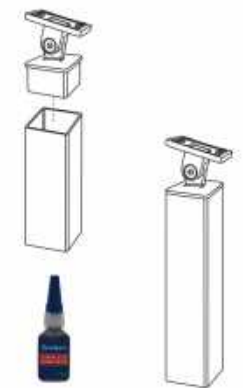
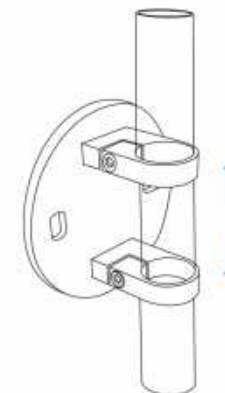
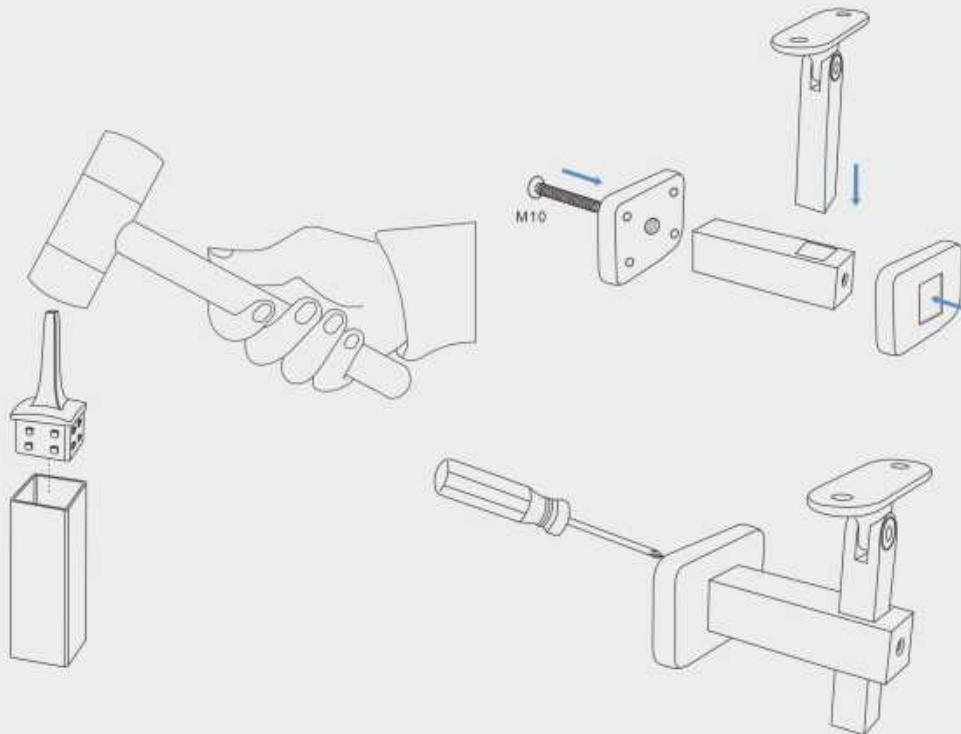



TJ-44

Item NO	D	ø
TJ-44-381-381	38.1	38.1
TJ-44-381-508	38.1	50.8
TJ-44-424-424	42.4	42.4
TJ-44-424-483	42.4	48.3
TJ-44-483-483	48.3	48.3
TJ-44-508-508	50.8	50.8



TJ-45

Item NO	D	ø
TJ-45-381-381	38.1	38.1
TJ-45-381-508	38.1	50.8
TJ-45-424-424	42.4	42.4
TJ-45-424-483	42.4	48.3
TJ-45-483-483	48.3	48.3
TJ-45-508-508	50.8	50.8

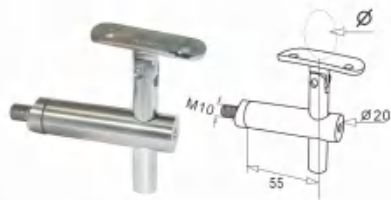

TJ-46

Item NO	ø
TJ-46-381	38.1
TJ-46-424	42.4
TJ-46-483	48.3
TJ-46-508	50.8

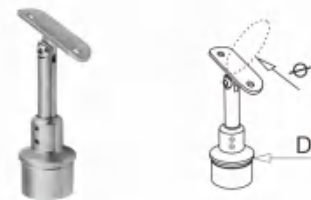

TJ-47

Item NO	D	ø
TJ-47-381-381	38.1	38.1
TJ-47-381-508	38.1	50.8
TJ-47-424-424	42.4	42.4
TJ-47-424-483	42.4	48.3
TJ-47-483-483	48.3	48.3
TJ-47-508-508	50.8	50.8



TJ-48

Item NO	ø1	ø2
TJ-48-381	38.1	100
TJ-48-424	42.4	100
TJ-48-508	50.8	109



TJ-49

Item NO	ø
TJ-49-381	38.1
TJ-49-424	42.4
TJ-49-508	50.8

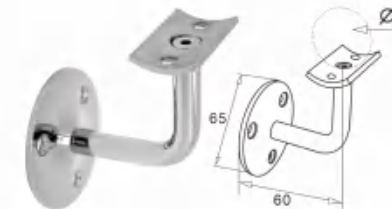

TJ-50

Item NO	ø
TJ-50-0	0
TJ-50-381	38.1
TJ-50-424	42.4
TJ-50-483	48.3
TJ-50-508	50.8

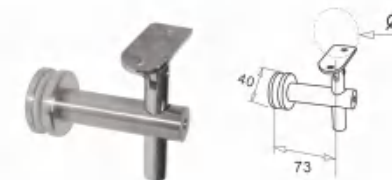

TJ-51

Item NO	ø
TJ-51-0	0
TJ-51-381	38.1
TJ-51-424	42.4
TJ-51-483	48.3
TJ-51-508	50.8

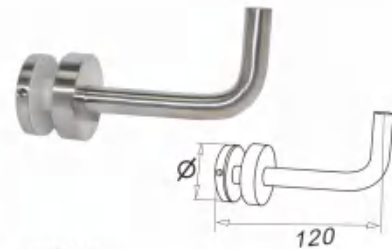

TJ-52

Item NO	ø
TJ-52-40	40



TJ-53

Item NO	ø
TJ-53-0	0
TJ-53-381	38.1
TJ-53-424	42.4
TJ-53-483	48.3
TJ-53-508	50.8

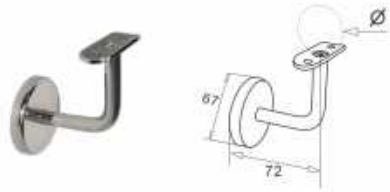

TJ-54	
Item NO	∅
TJ-54-381	38.1
TJ-54-424	42.4
TJ-54-483	48.3
TJ-54-508	50.8



TJ-55	
Item NO	∅
TJ-55-424	42.4



TJ-56	
Item NO	∅
TJ-56-10335	



TJ-57	
Item NO	∅
TJ-57-65	65



TJ-58	
Item NO	∅
TJ-58-25	25



TJ-59	
Item NO	∅
TJ-59-50	50



TJ-60	
Item NO	∅
TJ-60-50	50



TJ-61	
Item NO	∅
TJ-61-65	65



TJ-62	
Item NO	∅
TJ-62-65	65

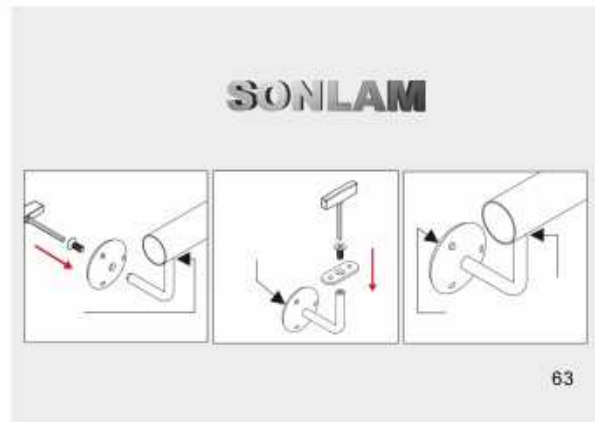
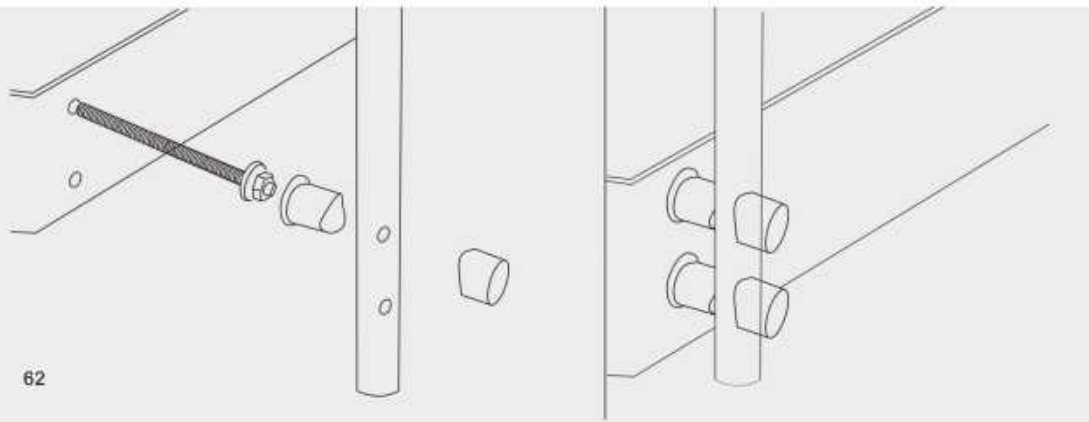



TJ-63	
Item NO	∅
TJ-63-381	38.1
TJ-63-424	42.4
TJ-63-483	48.3
TJ-63-508	50.8



TJ-64			
Item NO	∅ A	∅ B	H
TJ-64-254	25.4	65	65
TJ-64-381	38.1	65	75
TJ-64-508	50.8	65	75
TJ-64-424	42.4	65	75



TJ-65			
Item NO	∅ A	∅ B	H
TJ-65-254	25.4	65	65
TJ-65-381	38.1	65	75
TJ-65-508	50.8	65	75
TJ-65-424	42.4	65	75



TJ-66	
Item NO	∅
TJ-66-424	42.4



TJ-68	
Item NO	∅
TJ-68-508	50.8

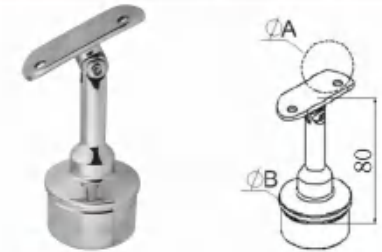

TJ-69		
Item NO	∅ A	∅ B
TJ-69-508-508	50.8	50.8



TJ-70		
Item NO	∅ A	∅ B
TJ-70-254-424	25.4	42.4



TJ-71		
Item NO	∅	L
TJ-71-424	42.4	100
TJ-71-0		100

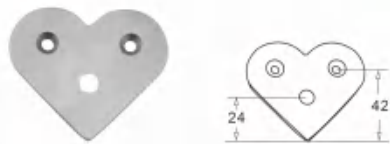

TJ-67	
Item NO	
TJ-67-0	



TJ-72	
Item NO	∅
TJ-72-508	50.8

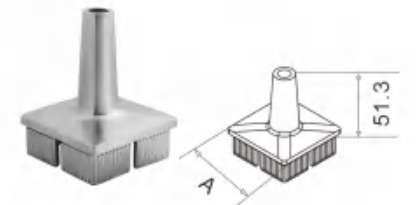

TJ-73	
Item NO	A
TJ-73-381-381	38.1×38.1
TJ-73-508-508	50.8×50.8

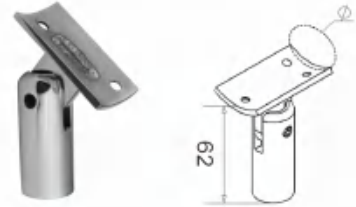

TJ-74
Item NO ϕ
TJ-74-0



TJ-75
Item NO ϕ
TJ-75-337 33.7

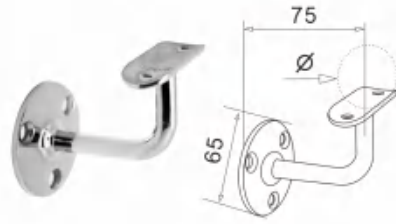

TJ-76
Item NO ϕ
TJ-76-508 50.8



TJ-77
Item NO ϕ
TJ-77-508 50.8

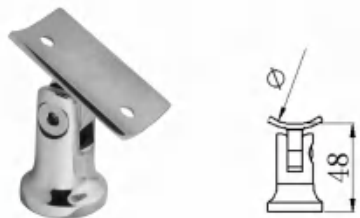

TJ-78
Item NO ϕ
TJ-78-508 50.8



TJ-79
Item NO ϕ
TJ-79-508 50.8



TJ-80
Item NO ϕ A
TJ-80-508 50.8

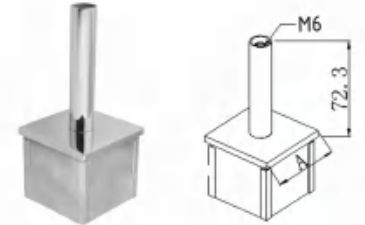

TJ-81
Item NO A
TJ-81-4040 40×40
TJ-81-5050 50×50

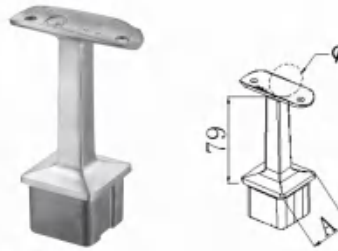

TJ-82
Item NO ϕ A
TJ-82-424 42.4 40×40

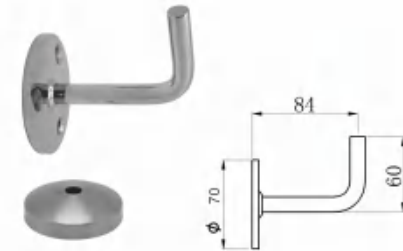

TJ-83
Item NO ϕ
TJ-83-70 70

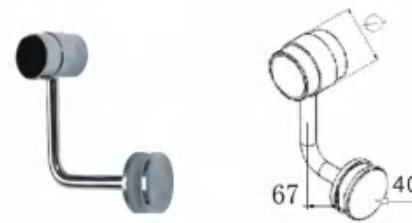

TJ-84
Item NO ϕ
TJ-84-508 50.8

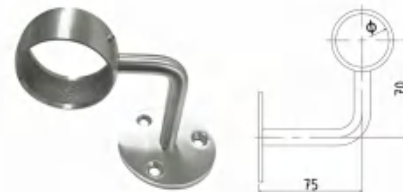

TJ-85
Item NO ϕ
TJ-85-381 38.1
TJ-85-508 50.8

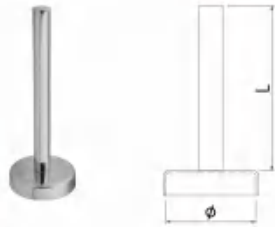

TJ-86		
Item NO	φ	L
TJ-86-381	38.1	100
TJ-86-25-70	25	70
TJ-86-38-70	38	70
TJ-86-424-70	42.4	70
TJ-86-508-70	50.8	70



TJ-87		
Item NO	D	φ
TJ-87-3838	38X38	0(flat)/38.1/42.4/50.8
TJ-87-4040	40X40	0(flat)/38.1/42.4/50.8
TJ-87-5050	50X50	0(flat)/38.1/42.4/50.8



TJ-88			
Item NO	φA	φB	H
TJ-88-508	50.8	70	178

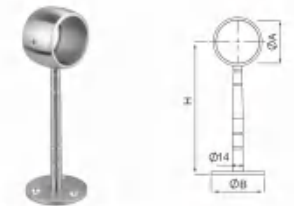

TJ-89			
Item NO	φA	φB	H
TJ-89-381-150	38.1	70	128
TJ-89-508-150	50.8	70	128
TJ-89-381-200	38.1	70	178
TJ-89-508-200	50.8	70	178

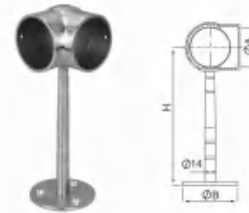

TJ-90			
Item NO	φA	φB	H
TJ-90-508	50.8	70	178

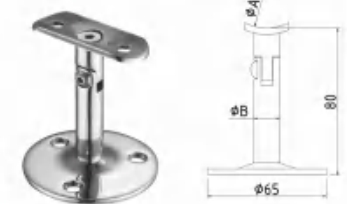

TJ-91		
Item NO	φA	φB
TJ-91-508	50.8	14

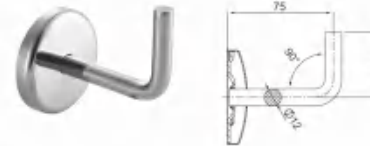

TJ-93		
Item NO	D	φ
TJ-93		



TJ-94		
Item NO	D	φ
TJ-94-508-381	50.8	38.1
TJ-94-381-508	38.1	50.8



TJ-95

Item NO	
TJ-95-0	



TJ-96

Item NO	∅A	∅B
TJ-96-508	50.8	16
TJ-96-508-14	50.8	14



TJ-97

Item NO	∅
TJ-97-381	38.1
TJ-97-424	42.4



TJ-98

Item NO	D	∅
TJ-98-381	38.1	38.1/42.4/50.8
TJ-98-508	50.8	38.1/42.4/50.8



TJ-102

Item NO	∅
TJ-102-381	38.1
TJ-102-0	0



TJ-105

Item NO	∅
TJ-105-508-508	50.8

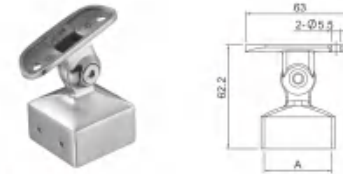

TJ-113

Item NO	A	∅
TJ-113-3030	30X30	0(flat)38.1/42.4/50.8
TJ-113-4020	40X20	0(flat)38.1/42.4/50.8
TJ-113-4040	40X40	0(flat)38.1/42.4/50.8
TJ-113-5050	50X50	0(flat)38.1/42.4/50.8

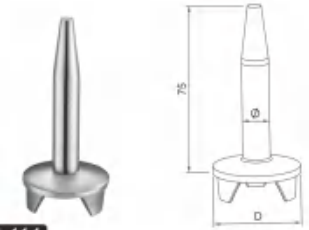

TJ-114

Item NO	D	∅
TJ-114-381	38.1	12
TJ-114-424	42.4	12
TJ-114-508	50.8	12

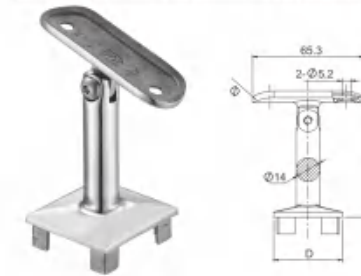

TJ-115

Item NO	D	∅
TJ-115-4040-508	40X40	50.8



TJ-116

Item NO	D	∅
TJ-116-381	38.1	12



TJ-117

Item NO	D	∅
TJ-117-381-508	38.1	50.8



TJ-118

Item NO	D	∅
TJ-118-381-508	38.1	50.8



TJ-133

Item NO	A	H
TJ-133-4040	40X40	
TJ-133-5050	50X50	



TJ-175

Item NO	ØA	ØB	H
TJ-175-381	38.1	12.7/16	
TJ-175-508	50.8	12.7/16	



TJ-144

Item NO	L	H
TJ-144-3838	38*38	O(flat)/Ø 38.1/Ø 42.4/Ø 50.8
TJ-144-4040	40*40	O(flat)/Ø 38.1/Ø 42.4/Ø 50.8
TJ-144-5050	50*50	O(flat)/Ø 38.1/Ø 42.4/Ø 50.8
TJ-144-8080	80*80	O(flat)/Ø 38.1/Ø 42.4/Ø 50.8

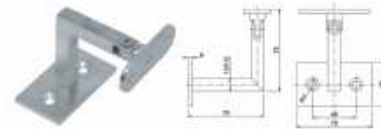

TJ-173

Item NO	L	H
TJ-173-0		



TJ-148

Item NO	Ø	H
TJ-148-381	381	
TJ-148-424	424	
TJ-148-508	508	



TJ-161

Item NO	Ø	H
TJ-161-424	424	



TJ-172

Item NO	Ø	H
TJ-172-381	38.1	
TJ-172-424	42.4	
TJ-172-508	50.8	

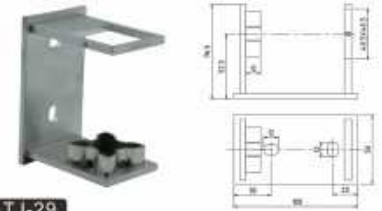

TJ-29

Item NO	L	H
TJ-29-4040	40	40

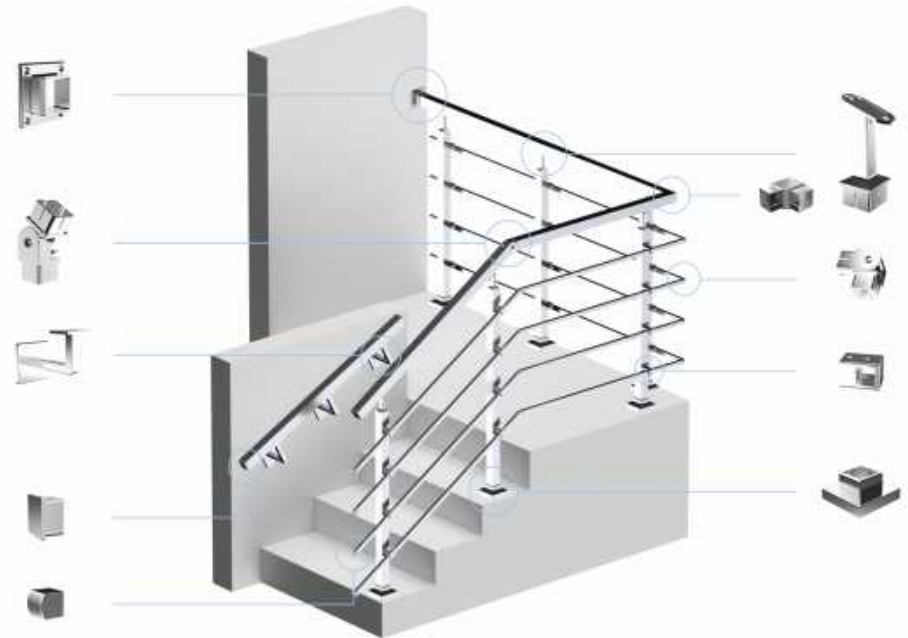



TU-09
Item NO ϕ
TU-09-254 25.4 tube slot 14X14mm

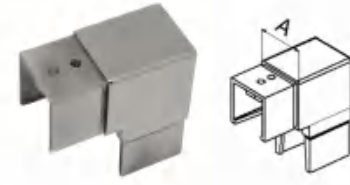

TU-10
Item NO A
TU-10-40 40x40 tube slot 24X24mm

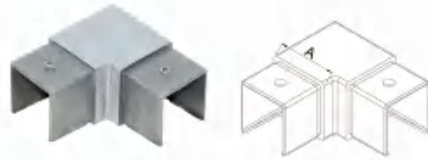

TU-11
Item NO A
TU-11-40 40x40 tube slot 24X24mm



TU-12
Item NO A B
TU-12-508254 50.8 25.4 tube slot 15X15mm



TU-13
Item NO A H
TU-13-2521 25 21 tube slot 14X14mm



TU-14
Item NO A B
TU-14-2521 25 21 tube slot 14X14mm



TU-15
Item NO A H
TU-15-2521 25 21 tube slot 14X14mm



TU-16
Item NO A B
TU-16-2521 25 21 tube slot 14X14mm

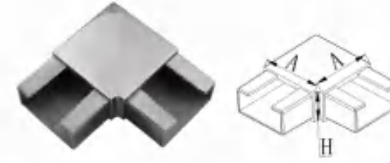

TU-17
Item NO A H
TU-17-508254 50.8 25.4 tube slot 15X15mm

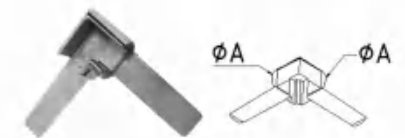

TU-18
Item NO A
TU-18-254 25.4 tube slot 14X14mm



TU-19
Item NO ϕ
TU-19-508 50.8 single slot 15x15mm

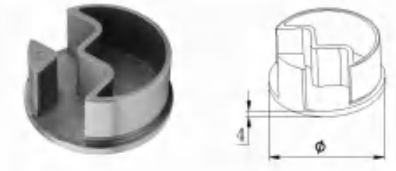

TU-20
Item NO ϕ
TU-20-508 50.8 90° double slot 15x15mm

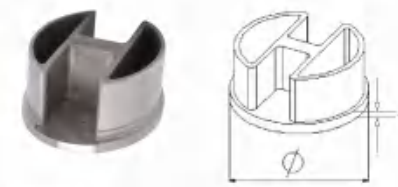

TU-21
Item NO ϕ
TU-21-508 50.8 double slot 15x15mm



TU-22
Item NO ϕ
TU-22-508 50.8 double slot 15x15mm



TU-23
Item NO ϕ
TU-23-508 50.8 90° 15x15mm

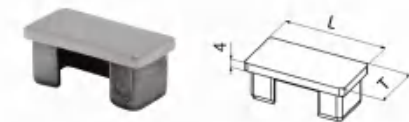

TU-24
Item NO L T
TU-24-508254 50.8 25.4 tube slot 15X15mm



TU-25		
Item NO	∅	
TU-25-254	25.4	tube slot 14×14mm



TU-26		
Item NO	∅	
TU-26-508	50.8	90° 15×15mm



TU-27		
Item NO	∅	
TU-27-508	50.8	single slot 15×15mm



TU-28		
Item NO	∅	
TU-28-508	50.8	double slot 15×15mm



TU-29		
Item NO	∅	
TU-29-254	25.4	tube slot 14×14mm



TU-30		
Item NO	∅	
TU-30-508	50.8	single slot 15×15mm



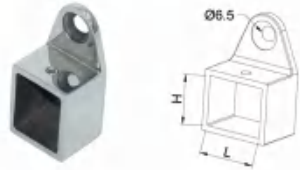

TU-35

Item NO	L	H
TU-35-2521	25	21
TU-35A-2521	21	25



TU-37

Item NO	Ø
TU-37-424	42.4
TU-37-483	48.3
TU-37-508	50.8



TU-41-2521

Item NO	L	H
TU-41-2521	25	21



TU-42

Item NO	L	H
TU-42-6040	60	40
TU-42-4040	40	40

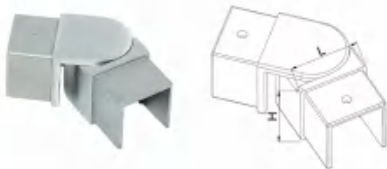

TU-33

Item NO	L	H
TU-33-2521	25	21
TU-33-4040	40	40



TU-41

Item NO	L	H
TU-41-4040	40	40
TU-41-6040	60	40
TU-41-5025	50	25

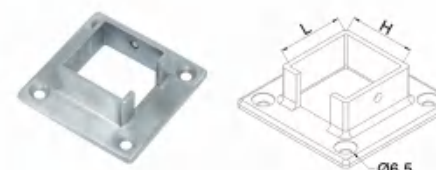

TU-38-4040

Item NO	L	H
TU-38-4040	40	40

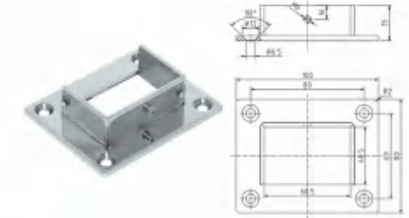

TU-38-6040

Item NO	L	H
TU-38-6040	60	40

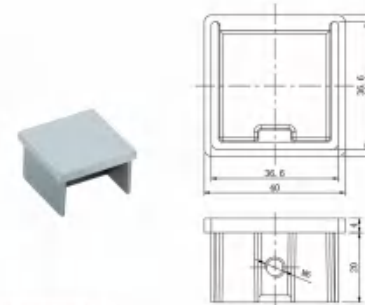

TU-24-4040

Item NO	L	H
TU-24-4040	40	40

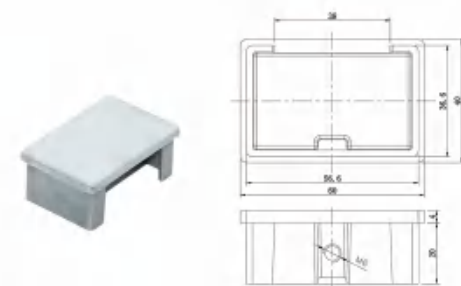

TU-24-6040

Item NO	L	H
TU-24-6040	60	40

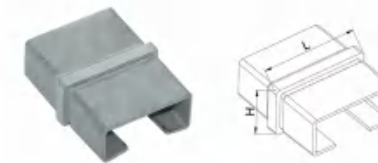

TU-31-5025

Item NO	L	H
TU-31-5025	50	25



TU-31

Item NO	L	H
TU-31-4040	40	40
TU-31-6040	60	40

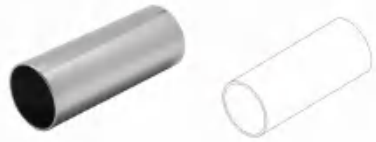

G-01	
Item NO	∅
G-01-12-1-5000	12
G-01-16-1-5000	16
G-01-254-1-5000	25.4
G-01-381-1-5000	38.1
G-01-424-1-5000	42.4
G-01-508-1-5000	50.8
G-01-635-12-5800	63.5
G-01-762-12-5800	76.2
G-01-1016-2-5800	101.6
G-01-12-15-6000	12
G-01-16-15-6000	16
G-01-254-15-6000	25.4

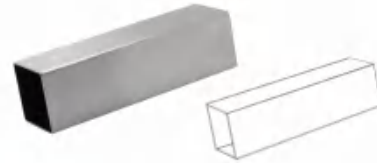

G-02		
Item NO	D1xD2	L1xL2
G-02-2513-1-5000	25x13	
G-02-2525-15-5000	25x25	
G-02-3030-15-5000	30x30	
G-02-4040-15-5000	40x40	
G-02-1515-15-5800	15x15	
G-02-2020-15-5800	20x20	
G-02-6030-15-5800	60x30	
G-02-4020-2-5800	40x20	
G-02-4040-2-5800	40x40	
G-02-8060-2-5800	80x60	
G-02-6040-25-5800	60x40	
G-02-100100-25-5800	100x100	



CG-01		
Item NO	∅	L1xL2
CG-01-1515-381	38.1	15x15
CG-01-23513-381	38.1	23.5x13
CG-01-2424-424	42.4	24x24
CG-01-1515-424	42.4	15x15
CG-01-2730-483	48.3	27x30
CG-01-13815-508	50.8	13.8x15
CG-01-1515-508	50.8	15x15
CG-01-2020-508	50.8	20x20
CG-01-2540-60	60	25x40
CG-01-2020-63	63	20x20
CG-01-2525-63	63	25x25
CG-01-2525-75	75	25x25



CG-02		
Item NO	D1xD2	L1xL2
CG-02-318318-1515	31.8x31.8	15x15
CG-02-7545-2025	75x45	20x25
CG-02-4040-2424	40x40	24x24
CG-02-6040-2424	60x40	24x24
CG-02-14050-2520	140x50	25x20



CG-03		
Item NO	∅	L1xL2
CG-03-1515-508	50.8	15x15
CG-03-2525-76	76	25x25

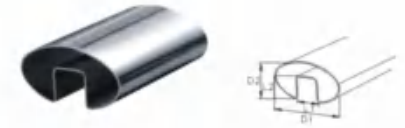

CG-04		
Item NO	D1xD2	L1xL2
CG-04-8765-2530	87x65	25x30
CG-04-8040-2424	80x40	24x24



CG-05		
Item NO	∅	L1xL2
CG-05-1515-508	50.8x1.5	15x15



CG-06		
Item NO	U	G
CG-06-24	24	8-12

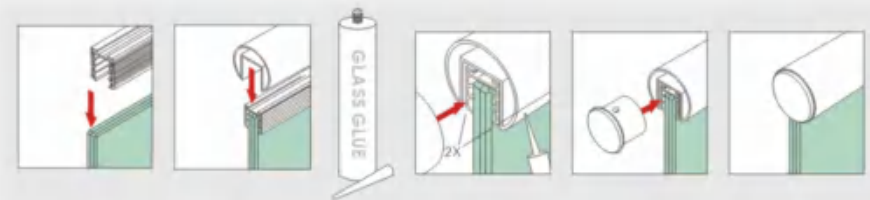

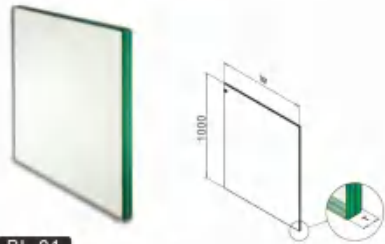

BL-01

Item NO	W	T
BL-01-100	100	17,52(8-1,52-8)
BL-01-200	200	17,52(8-1,52-8)
BL-01-300	300	17,52(8-1,52-8)
BL-01-400	400	17,52(8-1,52-8)
BL-01-500	500	17,52(8-1,52-8)
BL-01-600	600	17,52(8-1,52-8)
BL-01-700	700	17,52(8-1,52-8)
BL-01-800	800	17,52(8-1,52-8)
BL-01-900	900	17,52(8-1,52-8)
BL-01-950	950	17,52(8-1,52-8)
BL-01-1000	1000	17,52(8-1,52-8)
BL-01-1100	1100	17,52(8-1,52-8)
BL-01-1200	1200	17,52(8-1,52-8)



BL-02

Item NO	W	T
BL-02-100	100	17,52(8-1,52-8)
BL-02-200	200	17,52(8-1,52-8)
BL-02-300	300	17,52(8-1,52-8)
BL-02-400	400	17,52(8-1,52-8)
BL-02-500	500	17,52(8-1,52-8)
BL-02-600	600	17,52(8-1,52-8)
BL-02-700	700	17,52(8-1,52-8)
BL-02-800	800	17,52(8-1,52-8)
BL-02-900	900	17,52(8-1,52-8)
BL-02-950	950	17,52(8-1,52-8)
BL-02-1000	1000	17,52(8-1,52-8)

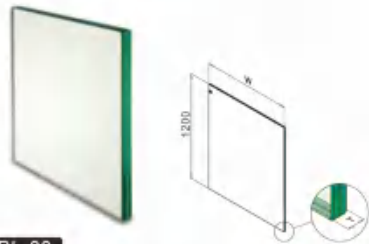

BL-03

Item NO	W	T
BL-03-100	100	17,52(8-1,52-8)
BL-03-200	200	17,52(8-1,52-8)
BL-03-300	300	17,52(8-1,52-8)
BL-03-400	400	17,52(8-1,52-8)
BL-03-500	500	17,52(8-1,52-8)
BL-03-600	600	17,52(8-1,52-8)
BL-03-700	700	17,52(8-1,52-8)
BL-03-800	800	17,52(8-1,52-8)
BL-03-900	900	17,52(8-1,52-8)
BL-03-950	950	17,52(8-1,52-8)
BL-03-1000	1000	17,52(8-1,52-8)

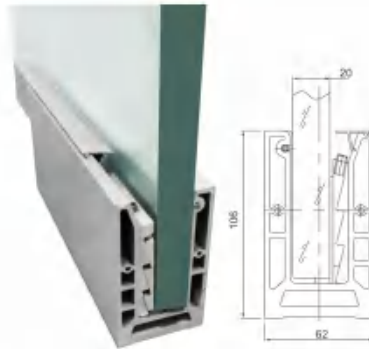

LHJGD-01

Item NO
LHJGD-01



T-01

Item NO	Ø
T-01-381	38.1
T-01-424	42.4
T-01-483	48.3
T-01-508	50.8



T-02

Item NO	Ø
T-02-381	38.1
T-02-424	42.4
T-02-483	48.3
T-02-508	50.8



T-03

Item NO	Ø
T-03-381	38.1
T-03-424	42.4
T-03-483	48.3
T-03-508	50.8



T-04

Item NO	Ø
T-04-381	38.1
T-04-424	42.4
T-04-483	48.3
T-04-508	50.8



T-05

Item NO	Ø
T-05-381	38.1
T-05-424	42.4
T-05-508	50.8

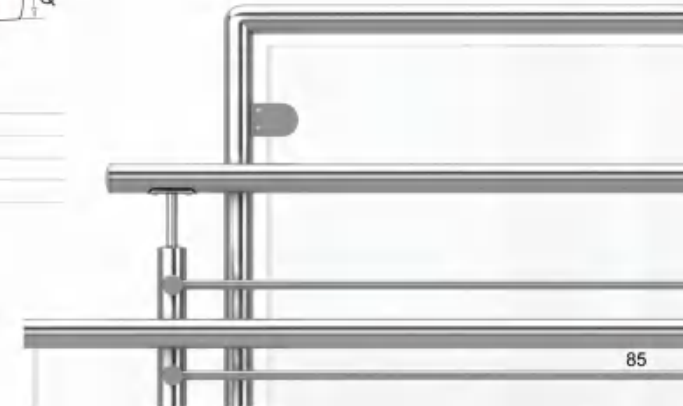

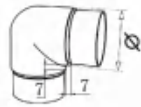

T-06

Item NO	∅
T-06-381	38.1
T-06-424	42.4
T-06-483	48.3
T-06-508	50.8



T-07

Item NO	∅
T-07-381	38.1
T-07-424	42.4
T-07-483	48.3
T-07-508	50.8

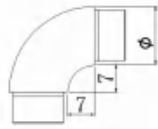

T-08

Item NO	∅
T-08-381	38.1
T-08-424	42.4
T-08-483	48.3
T-08-508	50.8



T-09

Item NO	∅
T-09-381	38.1
T-09-424	42.4
T-09-483	48.3
T-09-508	50.8

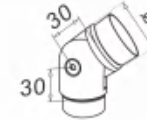

T-10

Item NO	∅
T-10-381	38.1
T-10-424	42.4
T-10-483	48.3
T-10-508	50.8

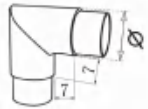

T-11

Item NO	∅
T-11-381	38.1
T-11-424	42.4
T-11-483	48.3
T-11-508	50.8



T-12

Item NO	∅
T-12-381	38.1
T-12-424	42.4
T-12-483	48.3
T-12-508	50.8

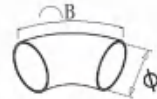

T-13

Item NO	∅	B
T-13-381	38.1	100
T-13-424	42.4	120
T-13-508	50.8	120
T-13-635	63.5	150
T-13-762	76.2	175
T-13-1016	101.6	225

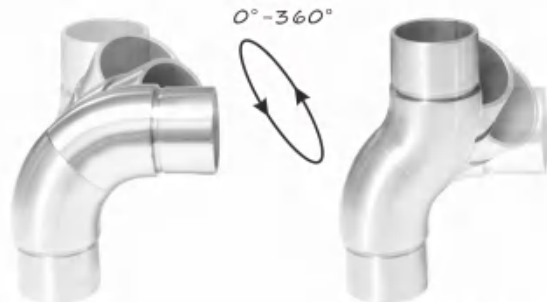

0°-360°



90°-270°



T-14

Item NO	Ø
T-14-381	38.1
T-14-424	42.4
T-14-483	48.3
T-14-508	50.8

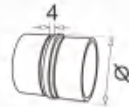

T-15

Item NO	Ø
T-15-381	38.1
T-15-424	42.4
T-15-508	50.8

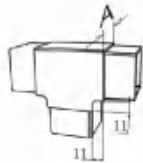

T-16

Item NO	A
T-16-4040	40x40
T-16-5050	50x50

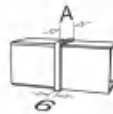

T-17

Item NO	A
T-17-4040	40x40
T-17-5050	50x50

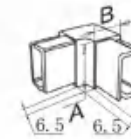

T-18

Item NO	A	B
T-18-2515	25	15
T-18-3020	30	20

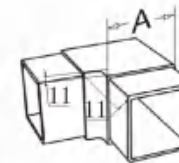

T-20

Item NO	A
T-20-3030	30X30
T-20-3838	38X38
T-20-4040	40X40
T-20-5050	50X50



T-19

Item NO	Ø
T-19-381	38.1
T-19-424	42.4
T-19-483	48.3
T-19-508	50.8

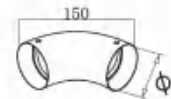

T-21

Item NO	Ø
T-21-495	49.5

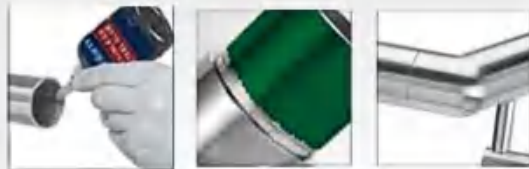



T-22	
Item NO	∅
T-22-49	49

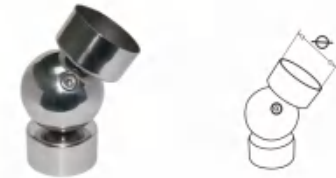

T-23	
Item NO	∅
T-23-508	50.8



T-24	
Item NO	∅
T-24-508	50.8



T-25	
Item NO	∅
T-25-508	50.8



T-26	
Item NO	∅
T-26-12	12
T-26-16	16

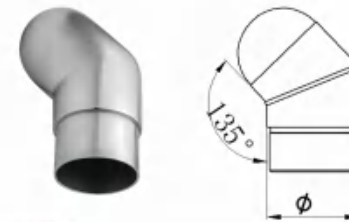

T-27	
Item NO	∅
T-27-424	42.4
T-27-508	50.8

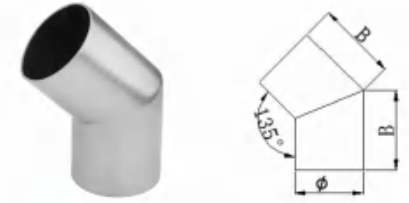

T-28		
Item NO	∅	B
T-28-381	38.1	44.3
T-28-508	50.8	59.5



T-29	
Item NO	∅
T-29-508	50.8

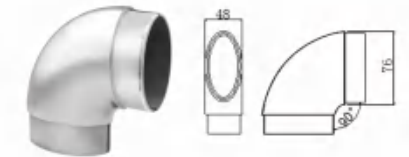

T-30		
Item NO	A	B
T-30-7648	76	48





T-31	
Item NO	∅
T-31-16	16

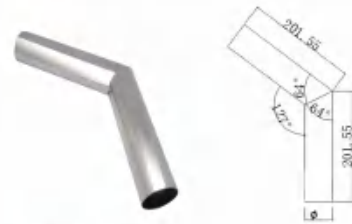

T-32	
Item NO	∅
T-32-508	50.8

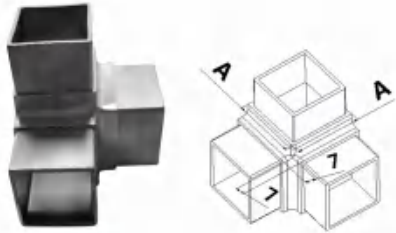

T-33	
Item NO	A
T-33-4040	40X40
T-33-5050	50X50

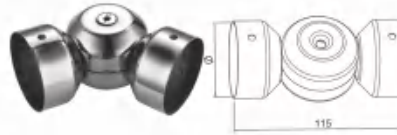

T-34	
Item NO	∅
T-34-508	50.8

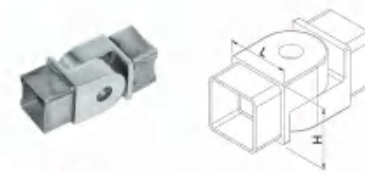

T-38		
Item NO	L	H
T-38-4040	40	40
T-38-5050	50	50



T-43		
Item NO	L	H
T-43-4040	40	40
T-43-5050	50	50



T-44		
Item NO	L	H
T-44-10015	100	15

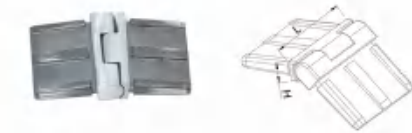

T-45		
Item NO	L	H
T-45-5010	50	10
T-45-10015	100	15



T-17		
Item NO	L	H
T-17-5010	50	10
T-17-10015	100	15



T-48	
Item NO	∅
T-48-12.7	12.7
T-48-13	13
T-48-16	16
T-48-19	19



T-20		
Item NO	L	H
T-20-5010	50	10



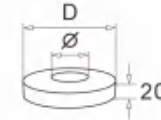
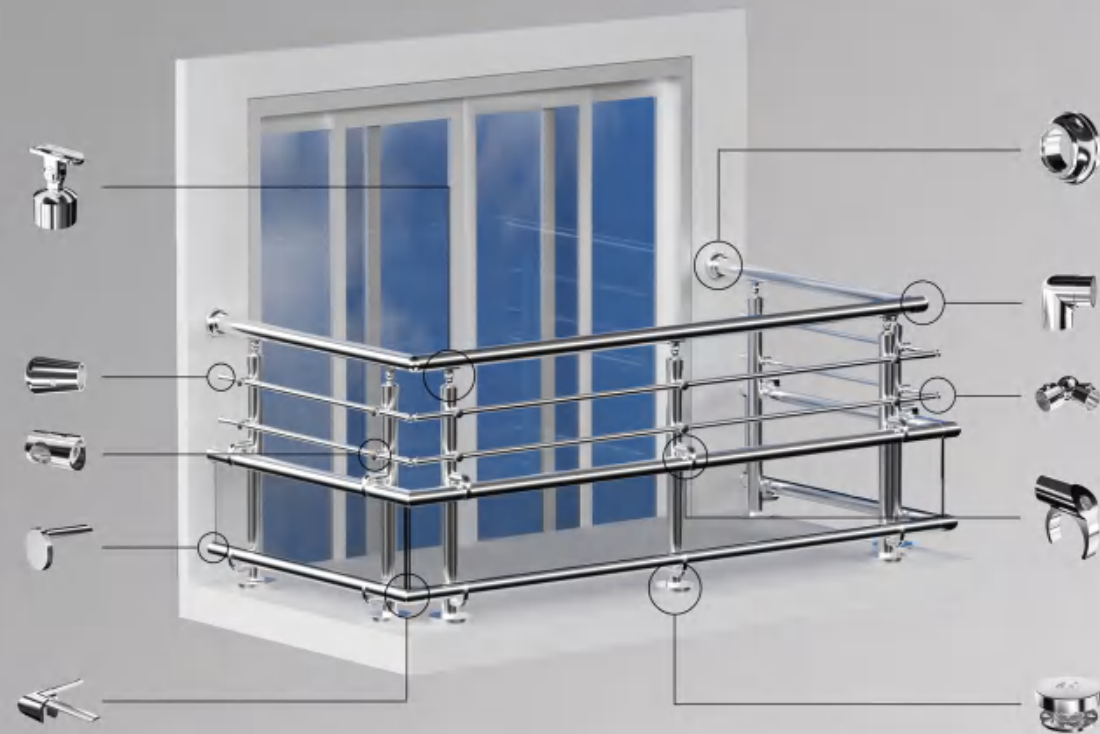

ZSG-01

Item NO	ø	D
ZSG-01-16	16	65
ZSG-01-381	38.1	102
ZSG-01-424	42.4	102
ZSG-01-508	50.8	102
ZSG-01-635	63.5	102
ZSG-01-762	76.2	120
ZSG-01-1016	101.6	150

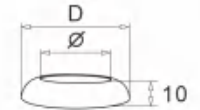

ZSG-02

Item NO	ø	D
ZSG-02-12	12	60
ZSG-02-16	16	60
ZSG-02-254	25.4	60
ZSG-02-381	38.1	60
ZSG-02-424	42.4	65
ZSG-02-508	50.8	74

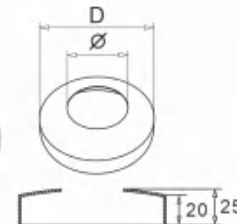

ZSG-03

Item NO	ø	D
ZSG-03-381	38.1	100
ZSG-03-424	42.4	100
ZSG-03-508	50.8	100

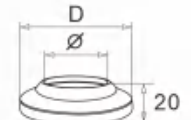

ZSG-04

Item NO	ø	D
ZSG-04-381	38.1	78
ZSG-04-424	42.4	78
ZSG-04-508	50.8	91

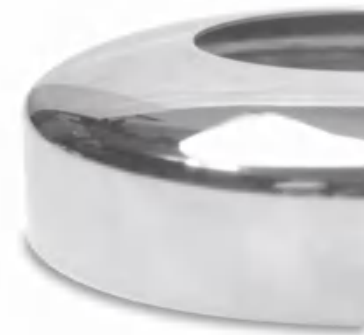
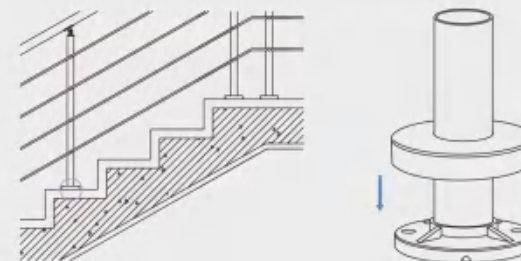

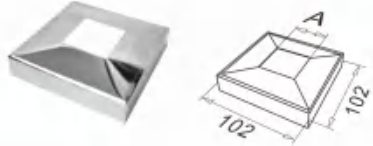

ZSG-05

Item NO	A
ZSG-05-4040	40×40
ZSG-05-5050	50×50



ZSG-06

Item NO	∅
ZSG-06-19T	19
ZSG-06-254T	25.4
ZSG-06-19Y	19
ZSG-06-254Y	25.4



ZSG-07

Item NO	A	L
ZSG-07-2525	25×25	80
ZSG-07-3030	30×30	80
ZSG-07-4040	40×40	80
ZSG-07-5050	50×50	100



ZSG-08

Item NO	∅
ZSG-08-508	50.8



ZSG-09

Item NO	∅ A	∅ B
ZSG-09-381	38.1	78
ZSG-09-424	42.4	78



ZSG-10

Item NO	∅
ZSG-10-508	50.8



ZSG-11

Item NO	∅
ZSG-11-508	50.8



ZSG-12

Item NO	∅
ZSG-12-508	50.8

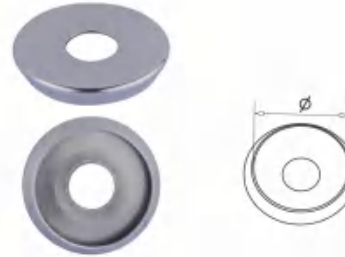

ZSG-13

Item NO	∅
ZSG-13-254	25.4

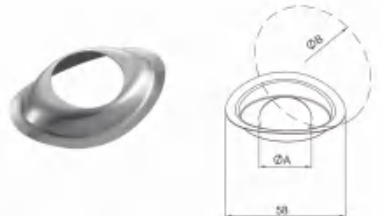

ZSG-16

Item NO	∅A	∅B
ZSG-16-254	25.4	50.8



ZSG-17

Item NO	A	B	C	D
ZSG-17-4020	20	40	80	80
ZSG-17-5025	25	50	75	100
ZSG-17-6008	8	60	80	100
ZSG-17-6030	30	60	80	100
ZSG-17-6040	40	60	80	100

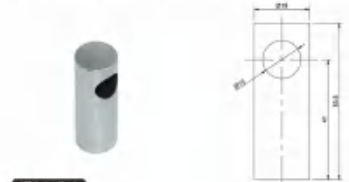

ZH-84

Item NO	L	∅
ZH-84-5313	53.5	13



glue
Stainless steel-- high-strength adhesive 1ML for each connector

FZ-01

Item NO	E
FZ-01	30ml



Cleanser
Spray for protecting stainless steel 400ML

FZ-04

Item NO	E
FZ-04-400	400ml

